

**DYNE X**™ ●●●

32" and 37" LCD TVs

**DX-32L151A11/DX-37L130A11**

**USER GUIDE**

# Dynex DX-32L151A11/DX-37L130A11 32" and 37" LCD TVs

## Contents

CHILD SAFETY .....	1
Important safety instructions .....	2
Warnings .....	2
Cautions .....	2
Installing the stand or removing the stand column .....	4
Installing the stand .....	4
Removing the stand column .....	4
Installing a wall-mount bracket .....	4
TV components .....	4
Accessories .....	4
Front .....	5
Side .....	5
Back .....	6
Remote control .....	6
Using the remote control .....	7
Installing remote control batteries .....	7
Aiming the remote control .....	8
Programming a universal remote control to work with your TV .....	8
Making connections .....	8
Selecting a location .....	8
Connecting the power .....	8
Connecting an HDMI device .....	9
Connecting a component video device .....	9
Connecting an antenna, cable TV, or satellite TV box .....	9
Connecting a VCR, camcorder, or game console .....	10
Connecting a computer .....	10
Connecting a home theater system .....	10
Connecting headphones .....	11
Turning on your TV for the first time .....	11
Understanding the basics .....	12
Turning your TV on or off .....	12
Selecting the video input source .....	12
Selecting a channel .....	12
Adjusting the volume .....	13
Displaying program information .....	13
On-screen menu overview .....	13
Navigating the menus .....	14
Adjusting basic settings .....	14
Adjusting the picture .....	14
Adjusting the TV picture .....	14
Adjusting the computer image .....	15
Adjusting the sound .....	15
Adjusting the sound .....	15
Selecting the audio mode .....	16
Playing TV audio only .....	16

Changing channel settings .....	17
Automatically scanning for channels .....	17
Selecting the signal source .....	17
Hiding channels .....	17
Setting up a favorite channel list .....	18
Adding or changing a channel label .....	18
Checking digital TV signal strength .....	19
Setting parental controls .....	19
Turning parental controls on or off .....	19
Setting or changing the password .....	20
Turning the button lock on or off .....	20
Setting parental control levels .....	21
Using closed captioning .....	23
Turning closed captioning on or off .....	23
Selecting the closed captioning mode .....	24
Customizing digital TV closed captioning styles .....	24
Adjusting time settings .....	25
Setting the date and time .....	25
Setting the sleep timer .....	26
Adjusting menu settings .....	26
Selecting the menu language and transparency .....	26
Labeling an input source .....	27
Restoring default settings .....	27
Troubleshooting .....	28
Video and audio .....	28
Remote control .....	28
General .....	28
Maintenance .....	29
Cleaning .....	29
Specifications .....	29
Legal notices .....	29
One-year limited warranty .....	31
US and Canada Markets .....	31
Mexico Market .....	31



# CHILD SAFETY

**It makes a difference how and where you use your flat panel display**

**As you enjoy your new product, keep these safety tips in mind**

## *The issue*

The home theater entertainment experience is a growing trend, and larger TVs are popular purchases. However, TVs are not always supported on the proper stands or installed according to the manufacturer's recommendations. We and the consumer electronics industry are committed to making home entertainment enjoyable and safe.

TVs that are inappropriately placed on dressers, bookcases, shelves, desks, speakers, chests, or carts may fall over and cause injury.

## *Tune into safety*

- One size of TV stand does **not** fit all. Use only a TV stand rated for the weight of your TV.
- Carefully read and understand all enclosed instructions for proper use of this product.
- Don't let children climb on or play with entertainment system furniture and TVs.
- Don't place TVs on furniture that can easily be used as steps, such as a crate or chest of drawers.
- Remember that children can become excited while watching a program, especially on a "larger-than-life" TV. Make sure that you place or install the TV where it cannot be pushed, pulled over, or knocked down.
- Make sure that you route all cords and cables so that they cannot be pulled or grabbed by curious children.



## *Wall mounting*

If you decide to wall mount your TV, always remember:

- One size of wall mount does **not** fit all. Use only a wall mount rated for the weight of your TV and that has been recommended by this TV manufacturer, listed in this manual, or otherwise listed by an independent laboratory as suitable for your TV.
- Follow all instructions supplied by the TV and wall mount manufacturers.
- If you have any doubts about your ability to safely wall mount your TV, get help from a professional installer.
- Make sure that the wall where you are mounting the TV is appropriate. Some wall mounts are not designed to be mounted to walls backed with steel studs or cinder blocks. If you are unsure, ask a professional installer.
- TVs can be heavy. At least two people are required for safe wall mount installation.



## Important safety instructions

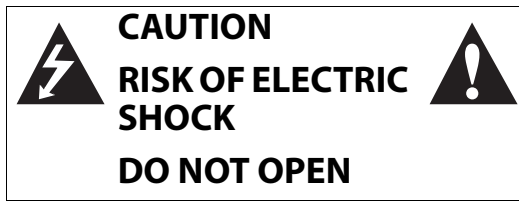

This symbol indicates that dangerous voltage constituting a risk of electric shock is present within your TV. This label is located on the back of your TV.



This symbol indicates that there are important operating and maintenance instructions in the literature accompanying your TV.

- 1 Read these instructions.
- 2 Keep these instructions.
- 3 Heed all warnings.
- 4 Follow all instructions.
- 5 Do not use this apparatus near water.
- 6 Clean only with a dry cloth.
- 7 Do not block any ventilation openings. Install in accordance with the manufacturer's instructions.
- 8 Do not install near any heat sources such as radiators, heat registers, stoves, or other apparatus (including amplifiers) that produce heat.
- 9 Do not defeat the safety purpose of the polarized or grounding-type plug. A polarized plug has two blades with one wider than the other. A grounding type plug has two blades and a third grounding prong. The wide blade or the third prong are provided for your safety. If the provided plug does not fit into your outlet, consult an electrician for replacement of the obsolete outlet.
- 10 Protect the power cord from being walked on or pinched particularly at plugs, convenience receptacles, and the point where they exit from the apparatus.
- 11 Only use attachments/accessories specified by the manufacturer.
- 12 Use only with a cart, stand, tripod, bracket, or table specified by the manufacturer, or sold with the apparatus. When a cart is used, use caution when moving the cart/apparatus combination to avoid injury from tip-over. 
- 13 Unplug this apparatus during lightning storms or when unused for long periods of time.
- 14 Refer all servicing to qualified service personnel. Servicing is required when the apparatus has been damaged in any way, such as power-supply cord or plug is damaged, liquid has been spilled or objects have fallen into the apparatus, the apparatus has been exposed to rain or moisture, does not operate normally, or has been dropped.
- 15 The wall plug is the disconnecting device. The plug must remain readily operable.
- 16 An apparatus with a three-prong, grounding-type plug is a Class I apparatus, which needs to be grounded to prevent possible electric shock. Make sure that you connect this Class I television to a grounding-type, three-prong outlet.
- 17 Remote control batteries should not be exposed to excessive heat such as sunshine, fire, or the like.

- 18 The apparatus should not be exposed to dripping or splashing, and no objects filled with liquids, such as vases, should be placed on the apparatus.

## Warnings

### Electric shock hazard

To reduce the risk of fire or electric shock, do not remove any cover or expose the device to rain or moisture. No user-serviceable parts are inside. Refer servicing to qualified service technicians.

### Lightning

For added protection for your device receiver during a lightning storm, or when it is left unattended and unused for long periods of time, unplug it from the power outlet and disconnect any antenna or cable system. This helps prevent property damage and personal injury from lightning and power line surges.

### Power lines

An outside antenna system should not be located in the vicinity of overhead power lines or other electric light or power circuits, or where it can fall into such power lines or circuits. When installing an outside antenna system, extreme care should be taken to keep from touching such power lines or circuits as contact with them might be fatal.

### Handling the LCD panel

- Your TV's screen is made of glass. Do not drop your TV or hit, jolt, or press hard against the LCD panel. If the screen breaks, be careful of broken glass.
- If the LCD panel is broken, make absolutely sure that you do not touch the liquid in the panel. This may cause skin inflammation.
- If the liquid gets in your mouth, immediately gargle, rinse, and consult with your doctor. Also, if the liquid gets in your eyes or touches your skin, consult with your doctor after rinsing for at least 15 minutes or longer in clean water.

### Replacement parts

When replacement parts are required, make sure that the service technician uses replacement parts specified by the manufacturer that have the same characteristics as the original part. Unauthorized substitutions may result in fire, electric shock, personal injury, or other hazards.

### Safety check

After completing any service or repair to this device, ask the service technician to perform routine safety checks to determine that your TV is in correct operating condition.

### Power source

Operate your TV only from the type of power source indicated on the marking label. If you are not sure of the type of power supplied to your home, consult an electrician or your local power company.

## Cautions

### Damage requiring service

Unplug this TV from the power outlet and refer servicing to qualified service personnel under the following conditions:

- When the power supply cord or plug is damaged or frayed.
- If liquid has been spilled or objects have fallen into your TV.
- If your TV has been exposed to rain or water.

- If your TV does not operate normally by following the operating instructions. Adjust only those controls that are covered by the operating instructions because incorrect adjustment of other controls may result in damage and will often require extensive work by a qualified technician to restore your TV to its normal operation.
- If your TV has been dropped or damaged in any way.
- When your TV exhibits a distinct change in performance.

**Outdoor antenna grounding**

If an outside antenna or cable system is connected to your TV, make sure that the antenna or cable system is grounded to provide some protection against voltage surges and built-up static charges. Article 810 of the National Electrical Code, ANSI/NFPA No. 70, provides information with respect to correct grounding of the mast and supporting structure, grounding of the lead-in wire to an antenna discharge unit, size of grounding conductors, location of the antenna-discharge unit, connection to grounding electrodes, and requirements for the grounding electrode.

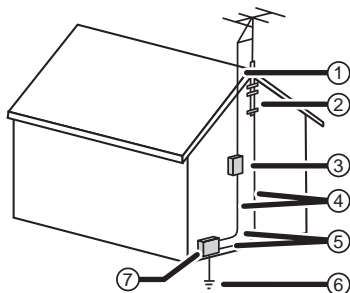

①	Antenna lead-in wire
②	Grounding clamp
③	Antenna discharge unit
④	Grounding conductors
⑤	Ground clamps
⑥	Power service grounding electrode system
⑦	Electric service equipment

**Note to CATV system installer**

Article 820 of the National Electrical Code, ANSI/NFPA No. 40 provides guidance for correct grounding. Specifically, it states that the cable ground must be connected to the grounding system of the building as close to the point of cable entry as practical.

**Condensation**

Moisture will form on the TV if the TV is brought from cool surroundings into a warm room or if the temperature of the room rises suddenly. When this happens, the TV's performance may be impaired. To prevent this, let the TV stand in its new surroundings for about an hour before switching it on, or make sure that the room temperature rises gradually. Condensation may also form during the summer if the TV is exposed to the breeze from an air conditioner. In such cases, change the location of the TV.

**Mobile telephone warning**

To avoid interference with your TV picture and sound, operating problems, or even damage, keep your cordless and cellular telephones away from the TV.

**End of life directives**

Your TV contains tin-lead solder and a fluorescent lamp containing a small amount of mercury. Disposal of these materials may be regulated for environmental reasons. Your TV also contains material that can be recycled and reused. For disposal or recycling information, contact your local authorities or the Electronic Industries Alliance at [www.eia.org](http://www.eia.org) to find a recycler in your area.

**Non-active pixels**

The LCD panel contains almost 3 million thin film transistors, which provide exceptionally sharp video quality. Occasionally, a few non-active pixels may appear on the screen as a fixed blue, green, or red point. These non-active pixels do not adversely affect the performance of your TV, and are not considered defects.

## Installing the stand or removing the stand column

### Cautions

- Read these instructions carefully before you try to assemble the stand or remove the stand column.
- Make sure that you handle the TV carefully when attempting to assemble or remove the stand. If you are not sure of your ability to do this, contact a professional installer or service technician. Dynex is not responsible for any damages or injuries that occur because of mishandling or incorrect assembly.
- Use a soft cushion or covering to prevent scratching or damage to the TV screen or cabinet.
- The speaker is not intended to support the weight of the TV. Do not move or handle the TV by the speaker. This can cause damage that is not covered by your warranty.
- Before assembly or removal of the stand, unplug the power cord. You must install your TV into the stand in order for it to stand upright on a cabinet or other flat surface. If you intend to mount your TV on a wall or other vertical surface, you must remove the stand column.

### Installing the stand

You must install the stand to use the TV in an upright position on a flat surface.

**Note:** Your TV may differ from the illustrations shown.

#### To install the stand:

- 1 Remove the stand from the box and place it on a table or bench.
- 2 Lay the TV (screen down) on the edge of the table or bench. Make sure that you put a soft cloth or cushion between the table or bench and the TV.

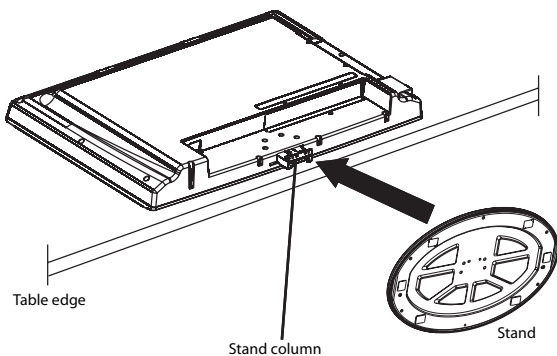

- 3 Align the locators on the stand column with the locating holes on the stand, then secure the stand to the column with the four M5 screws (provided).

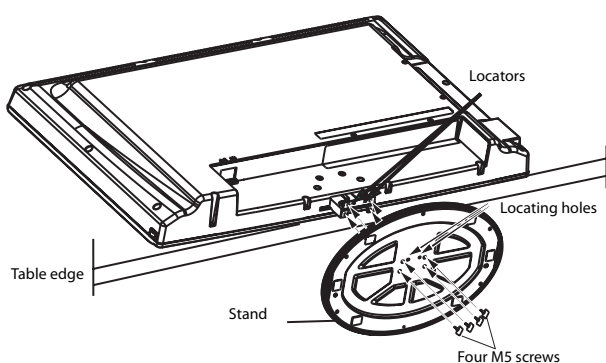

- 4 Carefully lift the TV into an upright position. To remove the stand, perform these steps in reverse order.

### Removing the stand column

You must remove the stand column before you can wall-mount the TV.

**Note:** Your TV may differ from the illustrations shown.

#### To remove the stand column:

- 1 Lay the TV (screen down) on the edge of the table or bench. Make sure that you put a soft cloth or cushion between the table or bench and the TV.
- 2 Remove the four screws holding the stand column to the TV, then remove the stand column.

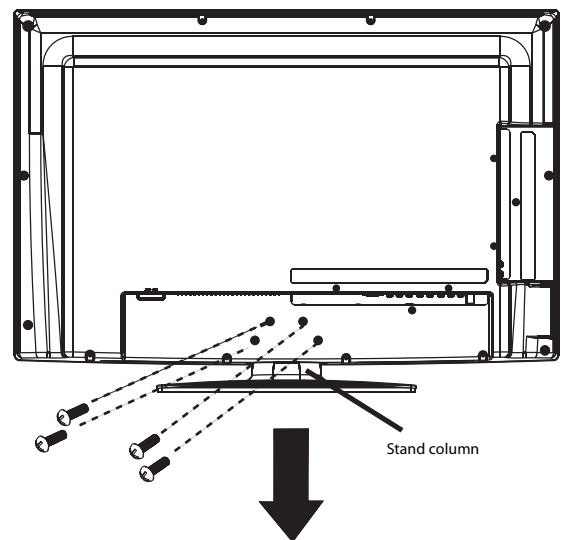

### Installing a wall-mount bracket

If you want to attach the TV to a wall-mount bracket (not provided), you should first remove the stand pedestal, if it is already attached.

#### To install a wall-mount bracket:

- 1 Lay your TV face down on a table or bench. Make sure that you put down a soft cushion or cloth so that your TV is not scratched.
- 2 Remove the pedestal stand.
- 3 Remove the stand column. See "Removing the stand column" on page 4.
- 4 Secure the wall-mount bracket to the back of your TV using the four M6 screws provided with the bracket.

## TV components

### Accessories

Make sure the following accessories are included in the box with your TV:

- Remote control
- Composite video & audio cable
- AC power cord
- AAA batteries (2)
- Stand
- Quick Start Guide



**Front**

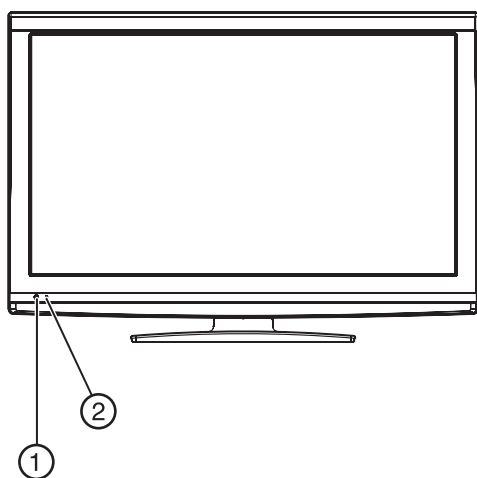

**Side**

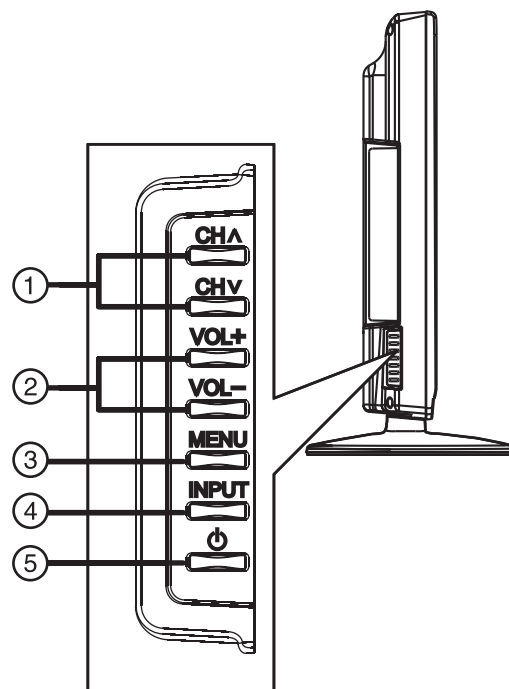

Item	Name	Description
①	Remote control sensor	Receives signals from the remote control. Do not block. For more information, see "Aiming the remote control" on page 8.
②	Power indicator	Lights red when your TV is in standby mode. Flashes red when your TV is turned on, then turns off when the TV stabilizes.

Item	Name	Description
①	<b>CH ^ / CH v</b>	In TV mode, press to select the next or previous channel. In menu mode, press to move up or down.
②	<b>VOL+ / VOL-</b>	In TV mode, press to increase or decrease the volume. In menu mode, press to move right or left or to adjust menu settings.
③	<b>MENU</b>	Press to open the on-screen menu.
④	<b>INPUT</b>	Press to open the <b>INPUT SOURCE</b> menu. For more information, see "Selecting the video input source" on page 12.
⑤	<b>⏻ (power)</b>	Press to turn on the TV or put the TV in standby mode. <b>Caution:</b> The TV continues to receive power even in standby mode. Unplug the power cord to disconnect power.

## Back

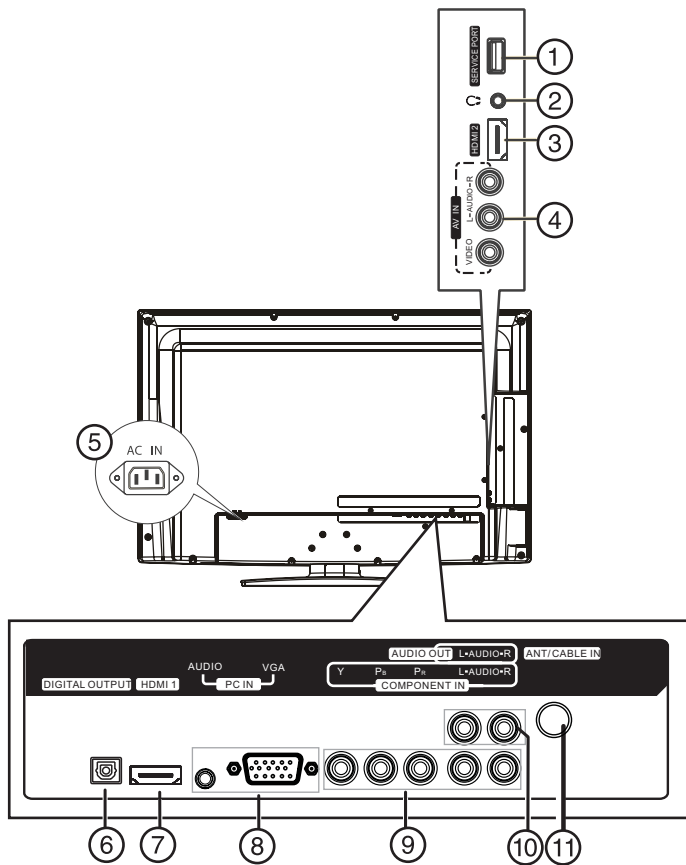

Item	Name	Description
①	<b>SERVICE PORT</b>	For software updates only. Do not use.
②	🎧 (headphone) jack	Plug headphones into this jack. For more information, see "Connecting headphones" on page 11.
③	<b>HDMI 2 jack</b>	Connect an HDMI device to this jack. For more information, see "Connecting an HDMI device" on page 9.
④	<b>AV IN jacks</b>	Connect a standard AV device, such as a camcorder or game console, to these jacks.
⑤	<b>AC IN</b>	Plug the power cord into this jack and into a power outlet. For more information, see "Connecting the power" on page 8.
⑥	<b>DIGITAL OUTPUT jack</b>	Connect a digital optical cable to this connector, then to a digital sound system. For more information, see "Connecting using a digital audio cable" on page 11.
⑦	<b>HDMI 1 jack</b>	Connect an HDMI device to this jack. For more information, see "Connecting an HDMI device" on page 9.
⑧	<b>PC IN VGA / AUDIO jacks</b>	Connect a computer to these jacks. For more information, see "Connecting a computer" on page 10.

Item	Name	Description
⑨	<b>COMPONENT IN jacks</b>	Connect component video devices to these jacks. For more information, see "Connecting a component video device" on page 9.
⑩	<b>AUDIO OUT jacks</b>	Connect an audio amplifier to these jacks. For more information, see "Connecting a home theater system" on page 10.
⑪	<b>ANT/CABLE IN jack</b>	Connect an antenna or cable TV to this jack. For more information, see "Connecting an antenna, cable TV, or satellite TV box" on page 9.

## Remote control

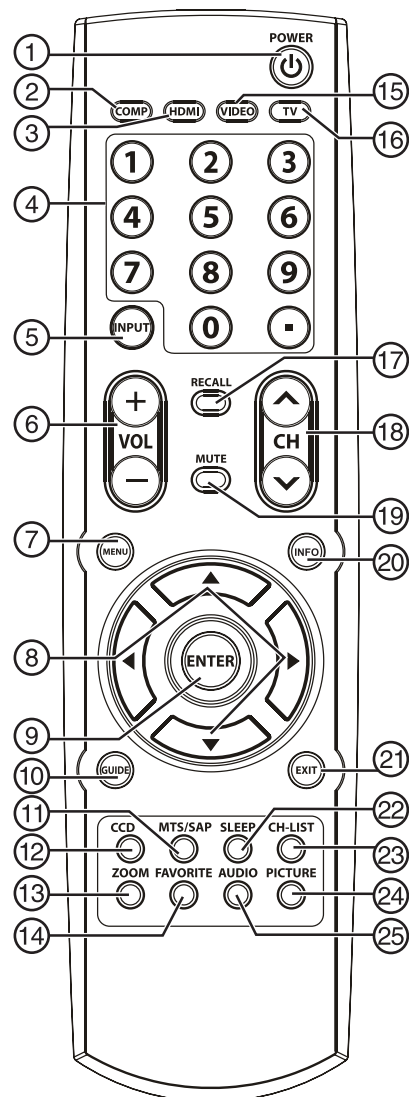

Item	Name	Description
①	<b>POWER</b> ⏻	Press to turn on the TV or put the TV in standby mode. <b>Caution:</b> The TV continues to receive power even in standby mode. Unplug the power cord to disconnect power.
②	<b>COMP</b>	Press to select the device connected to the COMPONENT IN jacks

Item	Name	Description
③	<b>HDMI</b>	Press once to select a device connected to the HDMI 1 jack. Press twice to select a device connected to the HDMI 2 jack.
④	Numbers/.	Press the number buttons to enter channel numbers or the parental control password. Press the dot button to select a digital sub-channel. For more information, see "Selecting a channel" on page 12.
⑤	<b>INPUT</b>	Press to open the <b>INPUT SOURCE</b> menu. For more information, see "Selecting the video input source" on page 12.
⑥	<b>VOL+ / VOL-</b>	Press to increase or decrease the volume.
⑦	<b>MENU</b>	Press to open the on-screen menu.
⑧	▲ ▼ ◀ ▶	Press ▲ or ▼ to move up or down in on-screen menus. Press ◀ or ▶ to move left or right in on-screen menus or to adjust menu settings.
⑨	<b>ENTER</b>	Press to confirm selections in on-screen menus or to open sub-menus.
⑩	<b>GUIDE</b>	Press to open the DTV program guide (if available). For more information, see "Displaying program information" on page 13.
⑪	<b>MTS/SAP</b>	In analog TV mode, press to select <b>STEREO</b> , <b>SAP</b> (secondary audio language), or <b>MONO</b> . In digital TV mode (DTV), press to select the audio track. For more information, see "Selecting the audio mode" on page 16.
⑫	<b>CCD</b>	Press to turn closed captioning on or off. For more information, see "Turning closed captioning on or off" on page 23.
⑬	<b>ZOOM</b>	Press to select the screen aspect ratio. You can select <b>Auto</b> , <b>Normal</b> , <b>Zoom</b> , <b>Wide</b> , and <b>Cinema</b> . For more information, see "Adjusting the TV picture" on page 14.
⑭	<b>FAVORITE</b>	Press to open the favorite channel list. For more information, see "Setting up a favorite channel list" on page 18.
⑮	<b>VIDEO</b>	Press to select the device connected to the AV IN Jack.
⑯	<b>TV</b>	Press to select the TV as the video input source. For more information, see "Selecting the video input source" on page 12.
⑰	<b>RECALL</b>	Press to go to the last viewed channel. For more information, see "Selecting a channel" on page 12.
⑱	<b>CH ^ /CH v</b>	Press to go to the next or previous channel in the channel list. For more information, see "Automatically scanning for channels" on page 17 and "Selecting a channel" on page 12.
⑲	<b>MUTE</b>	Press to mute the sound. Press again to restore the sound.
⑳	<b>INFO</b>	Press to display the information banner. For more information, see "Displaying program information" on page 13.
㉑	<b>EXIT</b>	Press to close the on-screen menu.
㉒	<b>SLEEP</b>	Press to set the sleep timer. For more information, see "Setting the sleep timer" on page 26.

Item	Name	Description
㉓	<b>CH-LIST</b>	Press to open the channel list. For more information see "Selecting a channel" on page 12.
㉔	<b>PICTURE</b>	Press to select the picture mode. You can select <b>Vivid</b> , <b>Standard</b> , <b>Theater</b> , <b>Sports</b> , <b>Energy Saving</b> , and <b>Custom</b> . For more information, see "Adjusting the TV picture" on page 14.
㉕	<b>AUDIO</b>	Press to select the sound mode. You can select <b>Standard</b> , <b>Movie</b> , <b>Music</b> , <b>News</b> , or <b>Custom</b> . For more information, see "Adjusting the sound" on page 15.

## Using the remote control

### Installing remote control batteries

#### To install remote control batteries:

- 1 Press down on the battery compartment cover lock, then remove the remote control cover.

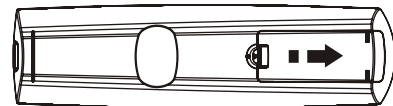

- 2 Insert two AAA batteries into the battery compartment. Make sure that the + and – symbols on the batteries match the + and – symbols in the battery compartment.
- 3 Replace the cover. Make sure that the lock snaps into place.

#### Battery precautions:

- Dispose of batteries as hazardous waste.
- Do not mix batteries of different types.
- Do not mix old and new batteries. Mixing old and new batteries can shorten the life of new batteries and can cause old batteries to leak.
- Remove batteries as soon as they become inoperable. Chemicals that can leak from the batteries can cause a rash. If the batteries leak, clean the battery compartment with a cloth.
- If the remote control is not used for an extended period of time, remove the batteries.
- Do not expose batteries to excessive heat such as sunshine, fire, or other heat sources.

## Aiming the remote control

### To aim the remote control:

- Point the remote control towards the remote sensor on the front of your TV.

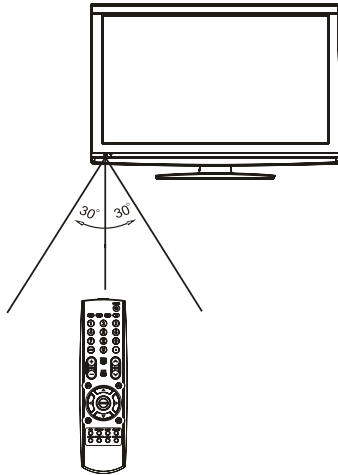

### Notes:

- Do not expose the remote control to shock or liquids.
- Do not use the remote control in an area with high humidity.
- Do not place the remote control in direct sunlight.
- Do not place objects, such as furniture, between the remote control and the remote sensor.
- The remote control may not work if direct sunlight or bright light shines on the remote sensor. Either move your TV or change the angle at which you use the remote control.

## Programming a universal remote control to work with your TV

You can operate your TV with a new or existing universal remote control.

### To program your existing universal remote control:

- To program your existing remote control to work with your Dynex TV, see the table below for common codes. If you have problems programming your remote, or need a different remote control code, visit [www.dynexproducts.com](http://www.dynexproducts.com) for the latest remote control code information.

#### Dynex TV codes for universal remote controls (for all Dynex TVs manufactured after Jan. 1, 2007)

##### Universal remote control manufacturer and model

Philips	RCA	One for All	Sony
PHDVD5, PH5DSS, PMDVR8, PDVR8	RCU807	URC-6690	RM-VL600

115

135

0464

8043

##### Set-top box manufacturer and model

Comcast	Dish	Motorola	TIVO	DirectTV
M1057	Network VIP508, VIP622	DRC800	Series 3, HD	RC23

0463

720

0463

0091

10463

Codes for other remote controls are available online at:  
<http://www.dynexproducts.com/universalcontrolcodes.aspx>

### Tips:

- The brand name is often visible on the front of the universal remote control, and the model number is often visible on the back.
  - The codes shown above are common codes, but are subject to change. Please refer to [Dynexproducts.com](http://www.dynexproducts.com) for the most up to date codes.
  - If your universal remote control isn't listed on the chart, refer to your universal remote control's instructions and try codes for the brands Orion, Emerson, Memorex, Sansui, Sylvania, or Zenith. You may need to try several codes before finding a match.
- Follow your universal remote control's instructions to enter the code you found in Step 1.
    - If your universal remote control has a code search feature, run a code search to identify a code that matches your TV. See your universal remote control's instructions for details.
    - If your universal remote control has a "learn" feature, you can manually program it using your TV remote to "teach" the commands one at a time. See your universal remote control's instructions for details.
  - If all else fails, you must use a different universal remote control that can operate both your set-top box and your TV. Five such remotes are listed on the chart, but many other compatible models are available in the market.
  - For more help, call technical support for your universal remote control or set-top box manufacturer, or call the Dynex Customer Care Center. For US and Canada markets, call 1-800-305-2204. For Mexico markets, call 01-800-926-3020.

## Making connections

Before you make any connections:

- Check the plugs on the ends of cables to make sure that they are the correct type before you try plugging them into jacks on the TV.
- Make sure that all plugs are securely inserted into the jacks. Loose connections can result in image or color problems.
- When connecting devices to the TV, make sure that the TV and the device are turned off and that the power cords are unplugged.

## Selecting a location

You should select a location for the TV:

- Where direct light does not reflect on the screen
- That has indirect and soft lighting
- Where the TV has access to an antenna or cable TV connection
- Where the TV has access to a power outlet

**Note:** Watching TV in total darkness or with a reflection on the screen may cause eye strain.

## Connecting the power

### To connect the power cord:

- Connect the power cable to the **AC IN** jack on the back of the TV, then connect the other end to a power outlet.

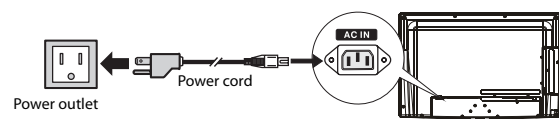

**Notes:**

- The AC plug on the TV may be different from the one shown.
- Make sure that you only use the type of power source indicated on the marking label.
- Always unplug the power cord when not using the TV for a long period of time.

## Connecting an HDMI device

**Note:** If your device has an HDMI connection, we recommend you use that to get the best quality possible.

**To connect an HDMI device:**

- Connect one end of an HDMI cable (not included) to the HDMI 1 jack on the back of your TV or HDMI 2 jack on the side of your TV, then connect the other end of the cable to the HDMI OUT jack on the HDMI device.

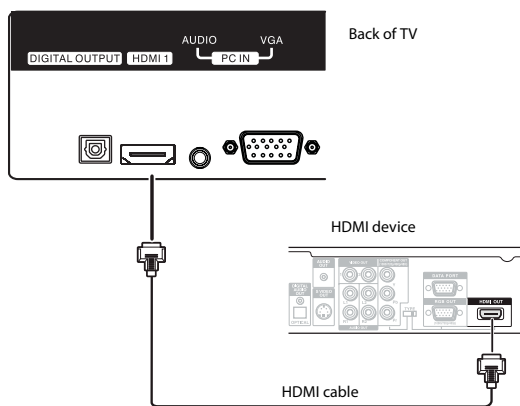

**Note:** To connect a DVI device, use a DVI to HDMI adapter cable to connect to the **HDMI** jack on the TV, then connect an audio cable to the **PC IN AUDIO** jack on the back of the TV.

**To play from the HDMI device:**

- 1 Turn on the TV, then press **INPUT**. The **INPUT SOURCE** menu opens.
- 2 Press **▲** or **▼** to select **HDMI 1** or **HDMI 2**, then press **ENTER**.

**Note:** You can also press **HDMI** once to select **HDMI 1** or twice to select **HDMI 2**.

- 3 Turn on the HDMI device, then set it to the correct mode. Refer to the instructions that came with the HDMI device.

## Connecting a component video device

Component cables often have red, green, and blue color-coded video connectors and red and white audio connectors. Match the colors when making connections.

**To connect a component video device:**

- 1 Make sure that your TV's power cord is unplugged and the component video device is turned off.
- 2 Connect a component video cable to the **COMPONENT OUT** jacks on the component video device.

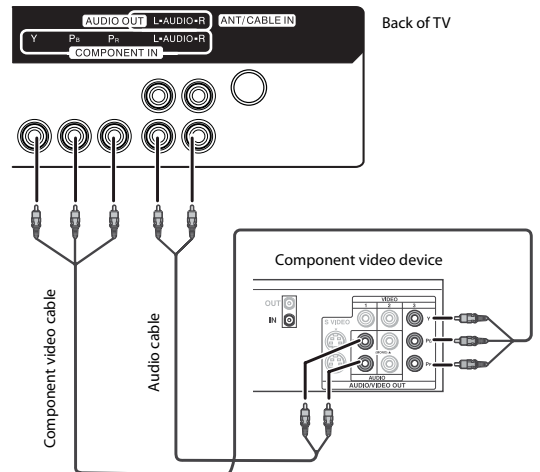

- 3 Connect the other end of the component video cable to the **COMPONENT** jacks on the back of your TV.
- 4 Connect an audio cable (not included) to the **AUDIO OUT** jacks (L/R) on the component device.
- 5 Connect the other end of the audio cable to the **COMPONENT AUDIO-R** and **AUDIO-L** jacks on the back of your TV.

**To play from the component video device:**

- 1 Turn on the TV, then press **INPUT**. The **INPUT SOURCE** menu opens.
- 2 Press **▲** or **▼** to select **Component**, then press **ENTER**.

**Note:** You can also press **COMP** once to select **Component**.

- 3 Turn on the component video device and start playback. Refer to the instructions that came with the component video device.

## Connecting an antenna, cable TV, or satellite TV box

**To connect an antenna, cable TV, or satellite TV box:**

- Connect one end of a 75-Ohm, coaxial cable to the **ANT/CABLE IN** jack on the back of the TV, then connect the other end of the cable to the antenna or cable TV wall jack.

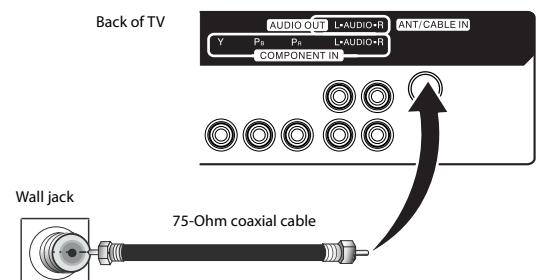

- If you are connecting a satellite TV or cable box, you can use one of the following (if available):
  - Acceptable - 75-ohm coaxial cable.

- Good - Video composite cable
- Better - Video component cables
- Best - HDMI cable

**Notes:**

- We recommend using a 75-Ohm, coaxial cable to reduce interference and noise that may be caused by radio wave transmissions.
- Do not bundle the coaxial cable with the power cord or any other cables.
- If you are using an antenna and reception is not good, contact a service technician to adjust the antenna.

## Connecting a VCR, camcorder, or game console

**Note:** If the VCR, camcorder, or game console has component jacks (better), or an HDMI jack (best), connect them using the best available connection.

**To connect a VCR, camcorder, or game console:**

- 1 Make sure that your TV's power cord is unplugged and the VCR, camcorder, or game console is turned off.
- 2 Connect one end of a standard AV cable (not included) into the **AV IN VIDEO** jack on the side of the TV, then connect the other end of the cable to the **AV OUT VIDEO** jack on the external device.

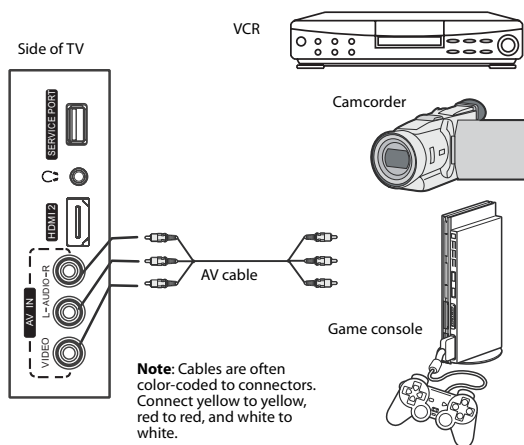

- 3 Connect the audio connectors of the AV cable (the red and white connectors) to the **AV OUT AUDIO** jacks of the external device, then connect them to the **AV IN AUDIO-L** and **AUDIO-R** jacks on the side of your TV.

**To play the external AV device:**

- 1 Turn on the TV, then press **INPUT**. The **INPUT SOURCE** menu opens.
- 2 Press **▲** or **▼** to select **AV**, then press **ENTER**.

**Note:** You can also press **VIDEO** once to select **AV**.

- 3 Turn on the device, then start playback on the device.

## Connecting a computer

**To connect a computer:**

- 1 Make sure that your TV's power cord is unplugged and the computer is turned off.
- 2 Connect one end of a VGA cable (not included) to the **PC IN VGA** jack on the back of the TV, then connect the other end of the cable to the **VGA** jack on the computer.

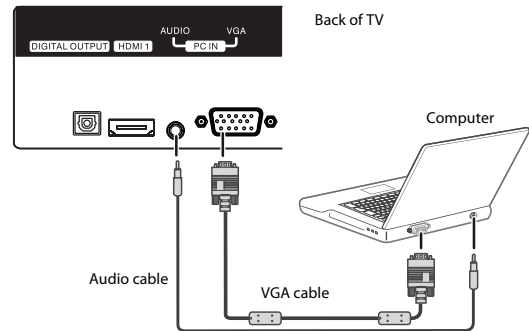

- 3 Connect one end of an audio cable (not included) to the **PC IN AUDIO** jack on the back of the TV, then connect the other end of the cable to the **AUDIO OUT** jack on the computer.

**Note:** The audio cable should have a stereo mini-plug.

**To play video from the computer:**

- 1 Turn on the TV, then press **INPUT**. The **INPUT SOURCE** menu opens.
- 2 Press **▲** or **▼** to select **VGA**, then press **ENTER**.
- 3 Turn on the computer, then adjust the computer display properties as needed.

## Connecting a home theater system

**Connecting using an analog audio cable**

**To connect using an analog audio cable:**

- 1 Make sure that your TV's power cord is unplugged and the audio amplifier is turned off.
- 2 Connect one end of a audio cable (not included) to the **AUDIO OUT** jacks (L/R) on the back of the TV.

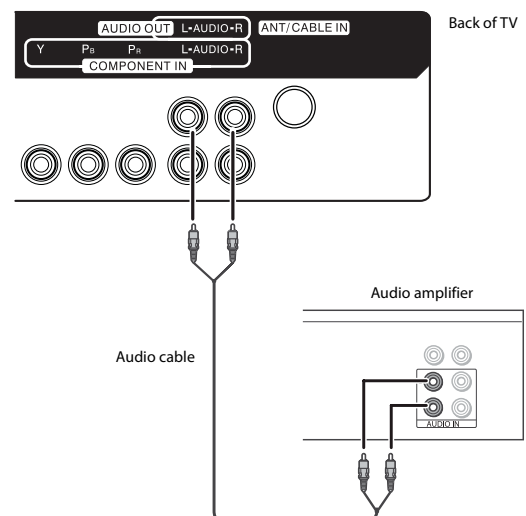

**Note:** Cable connectors and jacks are often color-coded. Match the colors when you connect the AV cable.

- 3 Connect the other end of the audio cable to the **AUDIO IN** jacks on the home theater system.

### Connecting using a digital audio cable

#### To connect using a digital optical cable:

- 1 Make sure that your TV's power cord is unplugged and the digital audio system is turned off.
- 2 Connect one end of a digital optical audio cable (not included) to the **DIGITAL OUTPUT** jack on the back of the TV.

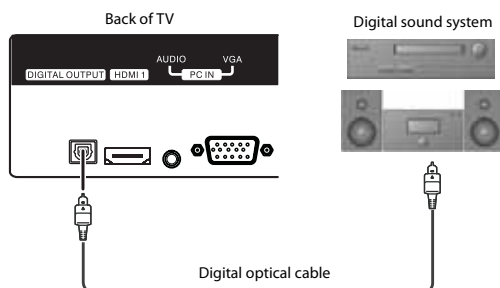

- 3 Connect the other end of the audio cable to the digital optical input jack on the digital audio system.

**Note:** The **DIGITAL OUTPUT** jack only works with digital TV channels.

#### To play TV sound through a home theater system:

- 1 Turn on the TV and select a program to watch.
- 2 Turn on the home theater system and select the TV sound source, then adjust the volume to a comfortable level.

### Connecting headphones

**Warning:** When using headphones, adjust the headphone volume to avoid excessively loud volume which can damage your hearing.

#### To connect headphones:

- Plug the headphones (not included) into the  (headphone) jack on the side of the TV.

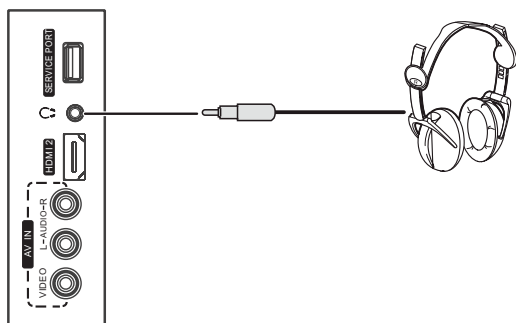



## Turning on your TV for the first time









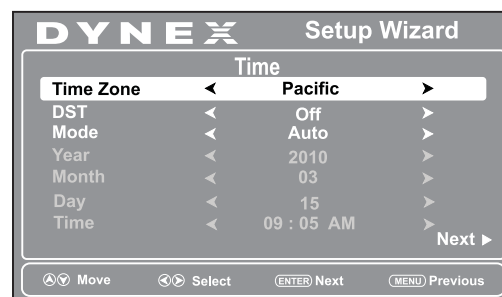













#### To configure your TV:

- 1 Make sure that you have inserted the batteries in the remote control, connected your devices to the TV, and connected the AC power.
- 2 Press  (Power), then wait several seconds. The initial *Setup Wizard* screen opens (only the first time you turn on your TV).



- 3 Press  or  to select the menu language you want, then press **ENTER**. The Time screen opens.



- 4 Press  or  to highlight **Time Zone**, then press  or  to select your time zone. You can select **Pacific, Alaska, Hawaii, Atlantic, Eastern, Central, or Mountain**.
- 5 If your viewing area observes daylight savings time, press  or  to highlight **DST**, then press  or  to select **On**.
- 6 Press  or  to highlight **Mode**, then press  or  to select **Manual** (to set the date/time manually), or **Auto** (the date/time are automatically set by the TV signal source, based on the time zone you selected).
- 7 If you select **Manual** mode, make the settings as follows:
  - Press  or  to highlight **Year, Month, or Day**, then press  or  to adjust the setting.
  - Set the time by pressing  or  to highlight **Time**, then press  or  to highlight the hour, minute, or AM/PM field. Press  or  to adjust the setting.
- 8 Press **ENTER**. The *Choose your Picture Mode* screen opens.

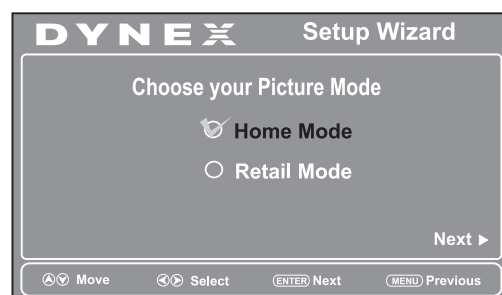

- 9 Press **▲** or **▼** to select **Home Mode** or **Retail Mode**, then press **ENTER**.

If you select **Home Mode**, the *Choose your TV source* screen opens.

-OR-

If you select **Retail Mode**, a message stating "Are you sure you want Retail mode? Since in this mode Energy saving is not realized." appears. Select **Yes** to proceed, or **No** to exit.

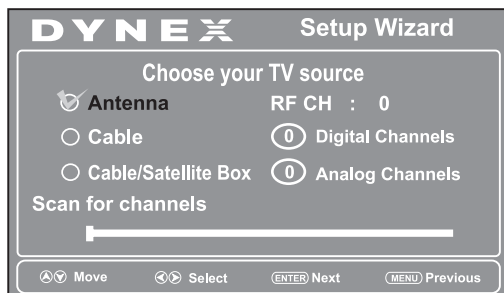

- 10 Press **▲** or **▼** to select **Antenna**, **Cable**, or **Cable/Satellite Box**, depending on the type of connection you have.
- If you are using an antenna for a standard or HD TV signal, select **Antenna**.
  - If your cable is connected directly to the TV (without a tuner box), select **Cable**.
  - If your cable is connected to your TV through a tuner box, select **Cable/Satellite Box**.
- 11 Press **▶** when you have made your selection. The channel scan screen opens.
- If you selected **Antenna** or **Cable**, your TV automatically scans for available channels in your area and stores the channel information in the channel list. This may take several minutes. While scanning, the TV displays a progress report.
- OR -
- If you selected **Cable/Satellite Box**, the auto scan is not necessary and the screen will ask you to select the correct input source for your set top box. Press **EXIT** to close the menu.
- Notes:**
- During auto scan, digital programs will be scanned first, then analog programs. When all available digital programs have been searched, the screen will ask you to "Press **MENU** or **EXIT** if you don't need analog channel scan." At this point you can press **EXIT** to exit the analog channel scan, or just ignore it and the TV will go on scanning.
  - Channel scan can take up to 30+ minutes.
  - You can press **EXIT** at any time to stop the auto scan, but you will need to run the auto scan again to create a channel list.
- 12 Select the corresponding video input source through the **INPUT SOURCE** menu.

## Understanding the basics

### Turning your TV on or off

**To turn your TV on or off (standby mode):**

- 1 Plug the power cord into an AC power outlet.
- 2 Press **⏻** (power). Your TV turns on.
- 3 Press **⏻** again to turn off your TV. When you turn off your TV, it goes into standby mode.

**Warning:** When your TV is in standby mode, it is still receiving power. To completely disconnect power, unplug the power cord.

**Note:** If your TV does not receive an input signal for several minutes, it automatically goes into standby mode.

### Selecting the video input source

**To select the video input source:**

- 1 Turn on your TV, then press the **INPUT** key on the remote, or the **INPUT** button on the TV. The **INPUT SOURCE** menu opens.

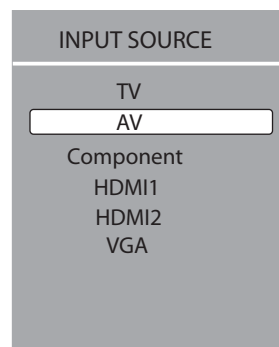

- 2 Press **▲** or **▼** to highlight the video source, then press **ENTER**. You can also select the input source using the following remote control buttons:
  - **VIDEO**—Press switch to AV input.
  - **HDMI**—Press repeatedly to cycle between HDMI inputs.
  - **TV**—Press to switch to TV mode.
  - **COMP**—Press to switch to Component input.

### Selecting a channel

**To select a channel:**

- Press **CH ▲** / **CH ▼** to go to the next or previous channel.
- Press the number buttons to enter the channel number you want, then wait for the channel to change, or press **ENTER** to change the channel immediately.
  - To select a digital channel, press the number buttons to select the main digital channel, then press the dot (.) button, then the number buttons again to select the sub-channel. Wait for the channel to change or press **ENTER** to change the channel.

**Note:** Button presses must be within three seconds of each other.

- Press **RECALL** to go to the last channel viewed.
- Press **CH-LIST** to display a list of memorized channels, press **▲** or **▼** to select the channel you want from the list, then press **ENTER** to go to that channel.
- Press **FAVORITE** to display a list of your saved favorite channels, press **▲** or **▼** to select the channel you want from the list, then press **ENTER** to go to that channel.



*Note: If the list has more than one page, press ◀ or ▶ to scroll through the pages.*

## Adjusting the volume

### To adjust the volume:

- Press **VOL+** or **VOL-** to increase or decrease the volume.
- Press **MUTE** to temporarily turn off all sound. Press **MUTE** again to restore the sound.

## Displaying program information

### To display program information:

- Press **INFO** to show an information banner. The information banner shows current program information such as channel number, video input source, and resolution.
  - **Digital signal information**—Displays channel number, station name, channel label (if preset), broadcast program name, TV rating, signal type, audio information, resolution, CC mode, current time, and current program start and end times when watching a digital channel.
  - **Analog signal information**—Displays channel number, channel label (if preset), signal type, audio information, and resolution when watching an analog channel.
- Press **GUIDE** to show the digital program guide, which may show a list of available programs, program times, and program summaries, depending on the information provided by the broadcaster.

## On-screen menu overview

### Picture menu

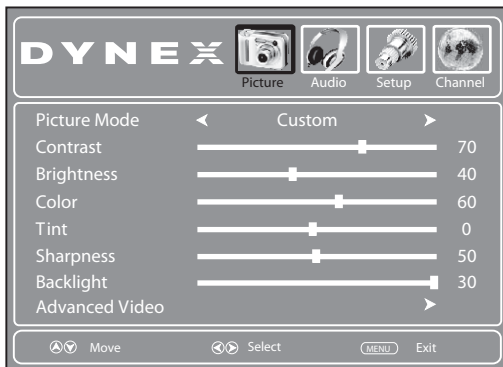

### Audio menu

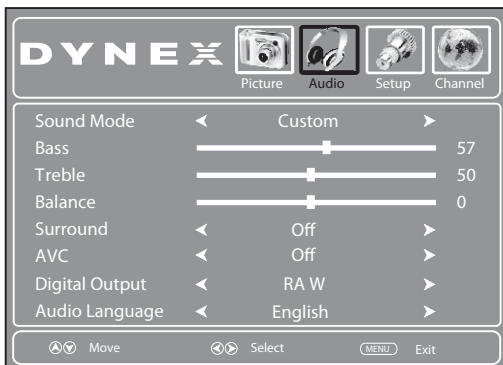

### Setup menu



### Channel menu

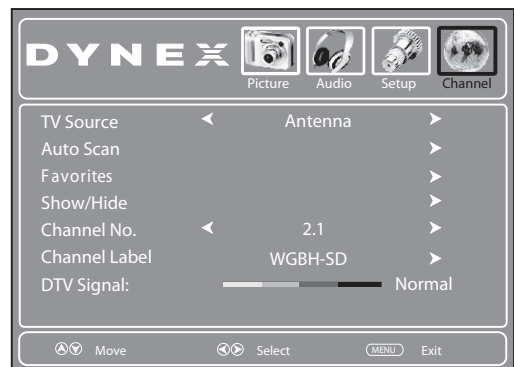

### Notes:

*Depending on the signal source selected, you may see different options on your screen. The above menus are shown in TV mode.*

*Menu items that are not selectable are grayed out. Menus in this manual are described in TV mode, unless otherwise indicated.*

*The illustrations and screens shown in the manual are for explanation purposes and may vary from the actual screens on your TV.*

## Navigating the menus

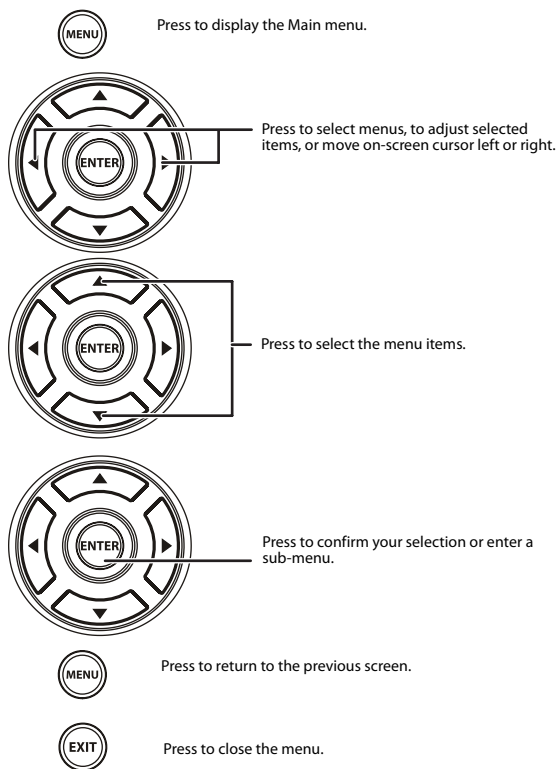

## Adjusting basic settings

To adjust basic settings:

- 1 Press **MENU**. The *Picture* menu opens.

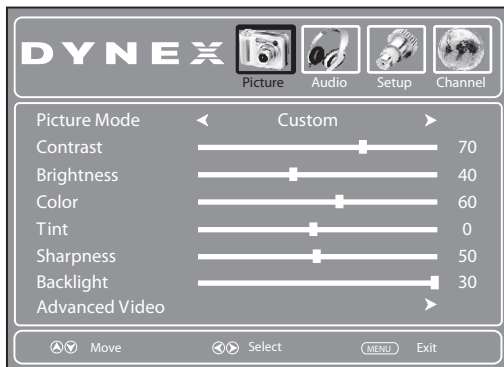

- 2 Press **◀** or **▶** to highlight **Setup**, then press **▼**. The *Setup* menu opens.



- 3 Press **▲** or **▼** to highlight an option, then press **ENTER** to enter the sub-menu. You can select:
  - **Parental Controls**—Control which programs/movies your children can watch, based on industry ratings.
  - **Time**—Set the clock and sleep timer.
  - **Closed Caption**—Turn closed captioning on or off. Also lets you set closed caption options.
  - **Menu Settings**—Set menu language and menu transparency.
  - **VGA Settings**—Lets you adjust picture settings to optimize a computer display. (This menu becomes available only when a computer display is connected to the television.)
  - **Input Label**—Create a unique name for a device connected to your TV's input jacks.
  - **Restore Default**—Reset most TV settings for the current source to factory default values.
  - **Audio Only**—Turn off the TV picture and listen to audio only.
- 4 Press **MENU** to return to the previous menu, or press **EXIT** to close the menu.

## Adjusting the picture

### Adjusting the TV picture

To adjust the picture:

- 1 Press **MENU**. The on-screen menu opens with the *Picture* menu displayed.

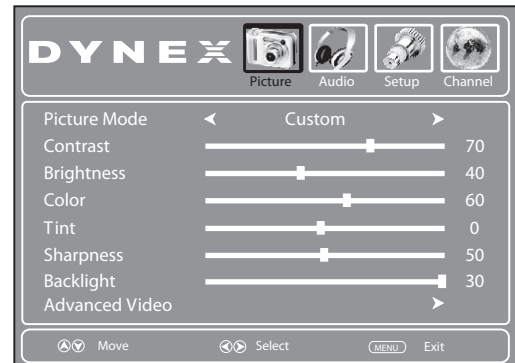

- 2 Press **▲** or **▼** to highlight an option, then press **◀** or **▶** to adjust the option. You can select:

- **Picture Mode**—Selects the picture mode. You can select:
  - **Vivid** (a bright and vivid picture)
  - **Standard** (a standard picture)
  - **Sports** (a dynamic picture)
  - **Theater** (a finely detailed picture)
  - **Energy Saving** (the backlight brightness is decreased)
  - **Custom** (customized picture).

**Note:** You can also press **PICTURE** on the remote control to select the picture mode.

- **Contrast**—Adjusts the contrast.
- **Brightness**—Adjusts the brightness.
- **Color**—Adjusts the color saturation.
- **Tint**—Adjusts the image tint.
- **Sharpness**—Adjusts the sharpness.
- **Backlight**—Adjusts the screen backlight.

- 3 Press **▲** or **▼** to highlight **Advanced Video**, then press **ENTER** to enter the sub-menu.

- 4 Press ▲ or ▼ to highlight an option, then press ◀ or ▶ to adjust the option. You can select:

- **Color Temperature**—Selects the color temperature. You can select **Warm** (to enhance the reds), **Cool** (to enhance the blues), or **Normal**.
- **Zoom Mode**— Selects the aspect ratio of the picture. You can select:
  - **Auto** (selects the correct aspect ratio automatically. Available only when Auto Zoom is turned ON).
  - **Normal** (selects the correct aspect ratio to match the source image).
  - **Wide** (shows a full-screen picture).
  - **Zoom** (enlarges the picture but may crop the top and bottom).
  - **Cinema** (stretches the picture at the edges, but maintains a good aspect ratio at the center of the screen).

**Notes:**

- The above aspect ratios are all available only when **Overscan** is turned **ON** when watching a digital program.
- You can also press **ZOOM** on the remote control to select the aspect ratio of the picture.
- **Noise Reduction**—Selects the noise reduction mode to reduce picture noise (snow). You can select **Weak**, **Middle**, **Strong**, or **Off**.
- **Overscan**—Turn this **On** to adjust the picture's reproduction rate.
- **Adaptive Contrast**—Turn this **On** to optimize the picture display for a more vivid image.
- **DCR**—Turn this **On** to activate the Dynamic Backlight Control function. Depending on the signal, the TV automatically adjusts the backlight level, which affects the overall brilliance of the picture.
- **Auto Zoom**—In TV mode, setting Auto Zoom to **On** lets you set the Zoom Mode to **Auto**.

- 5 Press **MENU** to return to the previous menu, or press **EXIT** to close the menu.

## Adjusting the computer image

**To adjust the computer image:**

- 1 Make sure that your TV is in VGA mode. For more information, see "Selecting the video input source" on page 12.
- 2 Press **MENU**. The on-screen menu opens.

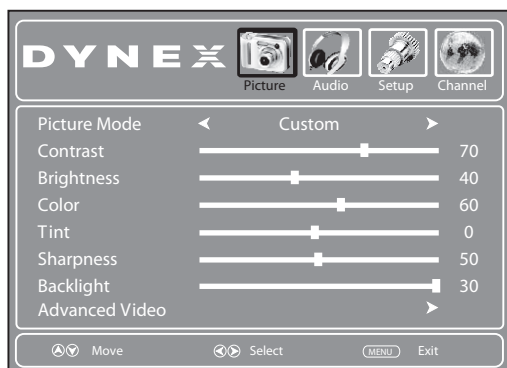

- 3 Press ◀ or ▶ to highlight **Setup**, then press ▼. The *Setup* menu opens.

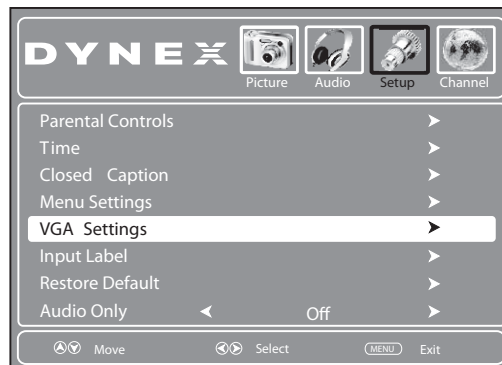

- 4 Press ▲ or ▼ to highlight **VGA Settings**, then press **ENTER**. The *VGA settings* menu opens.

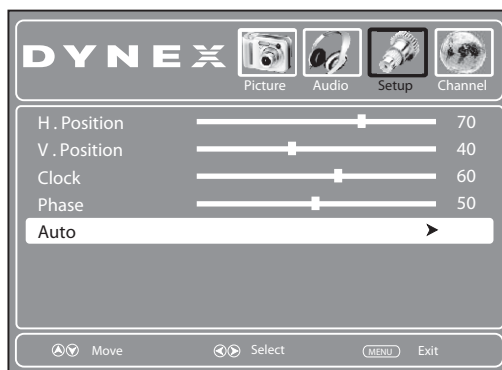

- 5 Press ▲ or ▼ to highlight an option, then press ◀ or ▶ to adjust the option. You can adjust:

- **H-Position**—Moves the image right or left
- **V-Position**—Moves the image up or down
- **Clock**—Adjusts the sample frequency
- **Phase**—Adjusts the focus of stable images
- **Auto**—Automatically adjusts the image settings such as position and phase

- 6 Press **MENU** to return to the previous menu, or press **EXIT** to close the menu.

## Adjusting the sound

### Adjusting the sound

**To adjust the sound:**

- 1 Press **MENU**. The on-screen menu opens.

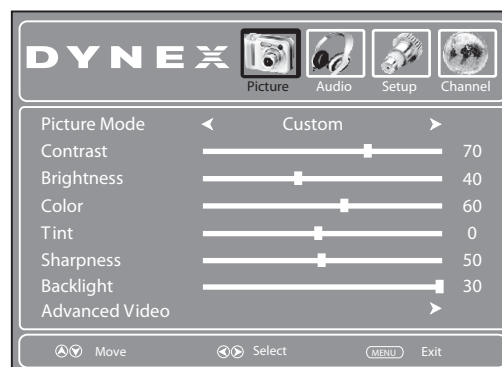

- 2 Press ◀ or ▶ to highlight **Audio**, then press ▼. The *Audio* menu opens.

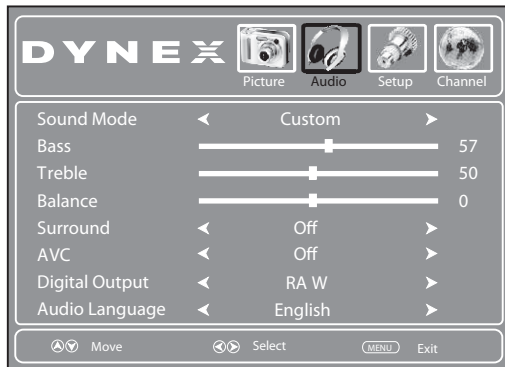

- 3 Press ▲ or ▼ to highlight an option, then press ◀ or ▶ to adjust the option. You can select:

- **Sound Mode**—Selects the sound mode. You can select:
  - **Standard** (for normal programs)
  - **News** (for news programs)
  - **Music** (for musical programs)
  - **Movie** (for movies)
  - **Custom** (for a customized sound mode).

**Note:** You can also press **AUDIO** one or more times to select the sound mode.

- **Bass**—Adjusts the low sounds.
- **Treble**—Adjusts the high sounds.
- **Balance**—Adjusts the balance between the left and right audio channels.
- **Surround**—Turns the surround sound effect on or off.
- **AVC**—(Auto volume control) Equalizes the overall volume levels for all channels.
- **Digital Output**—(digital channels only) Selects the digital audio output mode. You can select **RAW** (outputs audio in its original format) or **PCM** (outputs the audio in PCM mode, if available).
- **Audio Language**—(digital channels only) Selects an alternate audio language, if available.

- 4 Press **MENU** to return to the previous menu, or press **EXIT** to close the menu.

## Selecting the audio mode

You can select the audio mode for analog channels.

### To select the audio mode for analog channels:

- Press **MTS/SAP** on the remote one or more times. You can select:
  - **MONO**—Select this option if there is noise or static on weak stereo broadcasts.
  - **STEREO**—Select this option for programs broadcast in stereo.
  - **SAP**—Select this option to listen to a secondary audio program, if available.

**Note:** *Mono* is automatically selected if the program is broadcast in *mono*.

### To select an audio track for a digital channel:

- Press **MTS/SAP**. The audio track plays if one is available.

## Playing TV audio only

You can turn off the picture on your TV and listen to only the program audio.

### To play only the TV audio:

- 1 Press **MENU**. The on-screen menu opens.

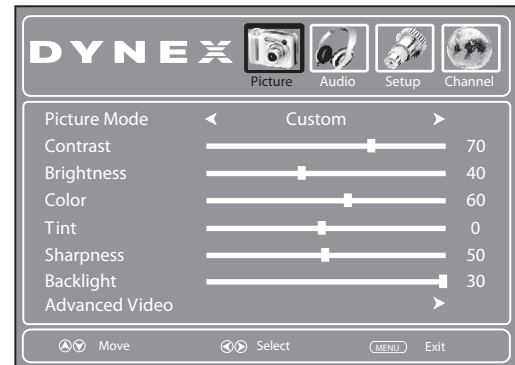

- 2 Press ◀ or ▶ to highlight **Setup**, then press ▼. The *Setup* menu opens.



- 3 Press ▲ or ▼ to highlight **Audio Only**, then press ◀ or ▶ to select **On**.
- 4 Press **EXIT** to close the menu. After pressing **EXIT**, the picture will turn off in approximately 5 to 10 seconds.

### Notes:

*Audio Only* works only when the input source is TV and your TV is receiving a broadcast signal.

To exit *Audio Only* mode, press any button. When you exit *Audio Only* mode, the *Audio Only* option is automatically reset to *Off*.

## Changing channel settings

### Automatically scanning for channels

To auto scan for channels:

- 1 Press **MENU**. The on-screen menu opens.

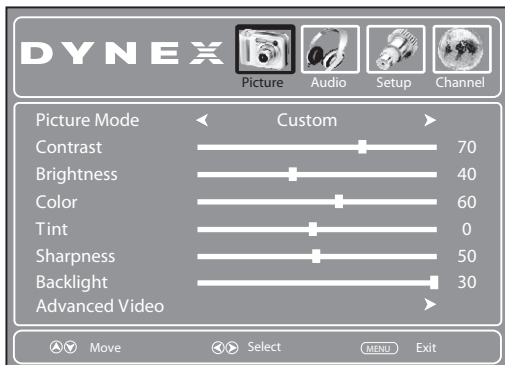

- 2 Press **◀** or **▶** to highlight **Channel**, then press **▼**. The **Channel** menu opens.

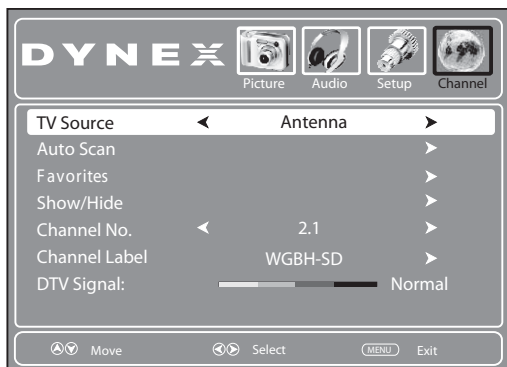

- 3 Press **◀** or **▶** to select **Antenna** or **Cable**, depending on your setup.
- 4 Press **▲** or **▼** to highlight **Auto Scan**, then press **ENTER**. A confirmation box opens.

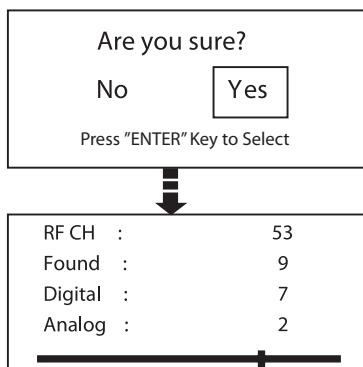

- 5 Press **◀** or **▶** to select **Yes**, then press **ENTER** to start the scan. A progress box shows the progress of the scan.

## Selecting the signal source

To select the signal source:

- 1 Press **MENU**. The on-screen menu opens.

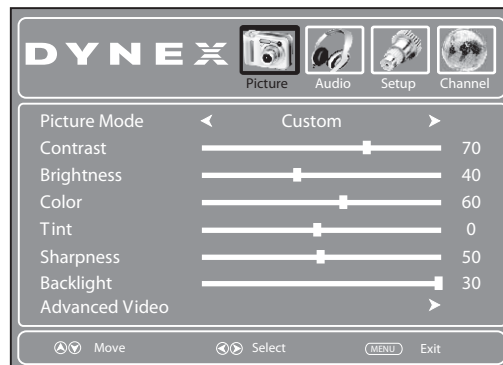

- 2 Press **◀** or **▶** to highlight **Channel**, then press **▼**. The **Channel** menu opens.

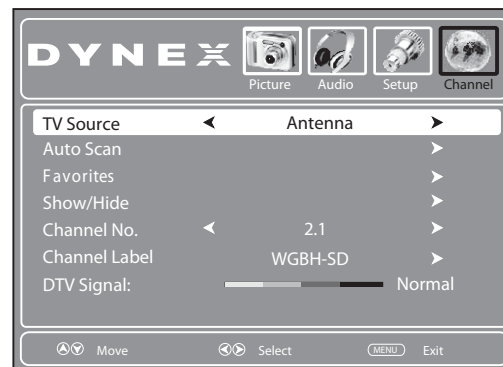

- 3 Press **◀** or **▶** to select **Antenna**, **Cable**, or **Cable/Satellite Box**.
- 4 Press **EXIT** to close the menu.

## Hiding channels

You can delete channels from the channel list so that your TV skips the channels when you press **CH▲/CH▼**. You can still tune to the hidden channel by using the number buttons.

To hide a channel:

- 1 Press **MENU**. The on-screen menu opens.

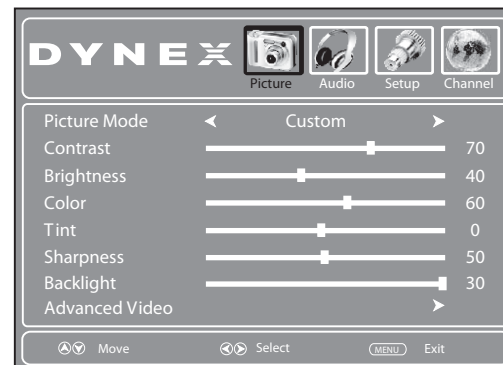

- Press **◀** or **▶** to highlight **Channel**, then press **▼**. The *Channel* menu opens.

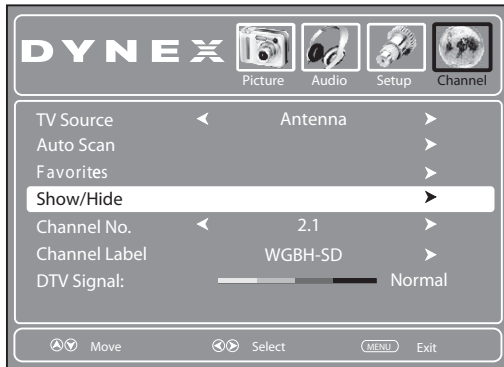

- Press **▲** or **▼** to highlight **Show/Hide**, then press **ENTER**. The channel list opens.

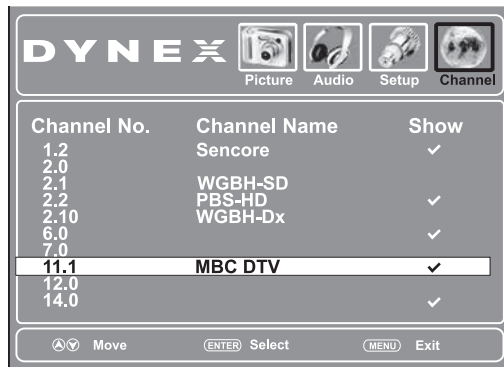

- Press **▲** or **▼** to highlight the channel you want to hide (the default is to show the channel), then press **ENTER** to remove the check mark from the channel.

**Note:** If the list has more than one page, press **◀** or **▶** to scroll through the pages.

- Press **EXIT** to close the menu.

## Setting up a favorite channel list

You can create a favorite channel list so you can quickly browse through your favorite channels by pressing **FAVORITE**, then selecting a channel from the favorite channel list.

**To set up the favorite channel list:**

- Press **MENU**. The on-screen menu opens.

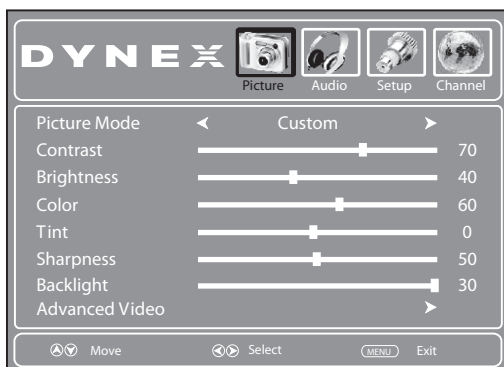

- Press **◀** or **▶** to highlight **Channel**, then press **▼**. The *Channel* menu opens.

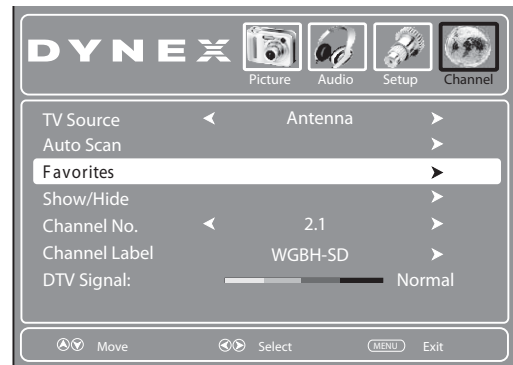

- Select the signal source of the channel you want to set up on the favorites list.

- Press **▲** or **▼** to highlight **Favorites**, then press **ENTER**. The favorite channel list opens.

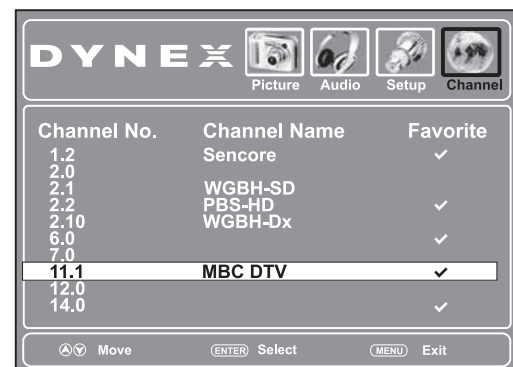

- Press **▲** or **▼** to highlight the channel you want to add to the favorite list, then press **ENTER** to mark the channel. A check mark appears if the channel is added to the list. The check mark disappears if you delete the channel from the list.

**Note:** If the list has more than one page, press **◀** or **▶** to scroll through the pages.

- Press **EXIT** to close the menu.

- To select a channel in the favorite channel list, press **FAVORITE**, press **▲** or **▼** to highlight the channel, then press **ENTER**.

## Adding or changing a channel label

If a channel is not already labeled, you can label the channel to make it easier to identify. You can also relabel a channel that is already labeled.

**To label a channel:**

- Press **MENU**. The *Picture* menu opens.

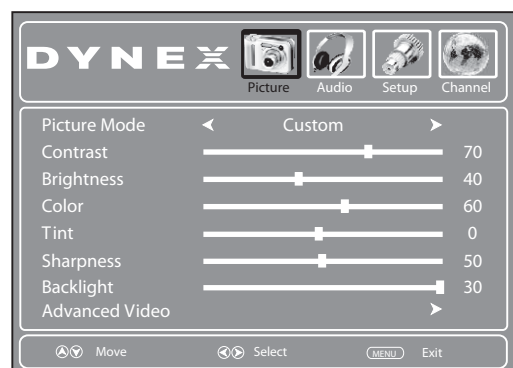

- Press **◀** or **▶** to highlight **Channel**, then press **▼**. The *Channel* menu opens.

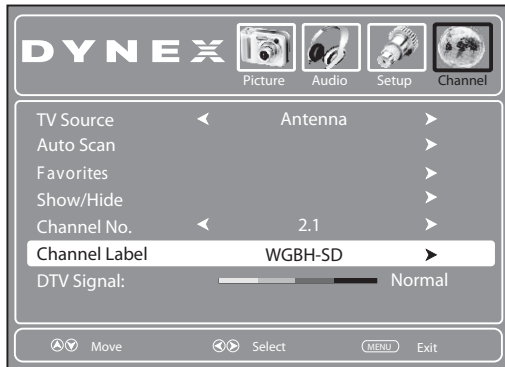

- Select the signal source of the channel you want to label.
- Press **▲** or **▼** to highlight **Channel No.**, then press **◀** or **▶** to select the channel you want to label.
- Press **▲** or **▼** to highlight **Channel Label**, then press **ENTER**. The *Channel Label* screen opens.

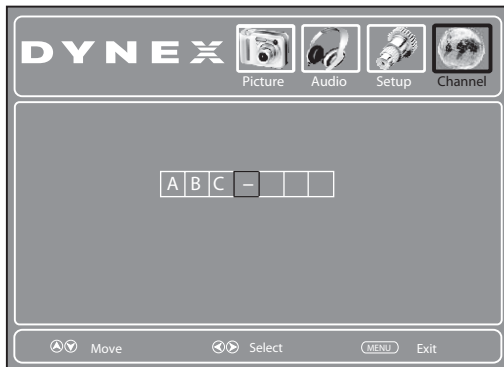

- Press **▲** or **▼** to select a character, then press **◀** or **▶** to move to the next position. Repeat to add more characters.
- Press **MENU** to exit to the previous menu.

### Checking digital TV signal strength

You can check the signal strength of digital channels to determine if you need to adjust your antenna or digital cable input. The higher the signal strength, the less likely you are to experience picture degradation.

#### To check signal strength:

- Press **MENU**. The on-screen menu opens.

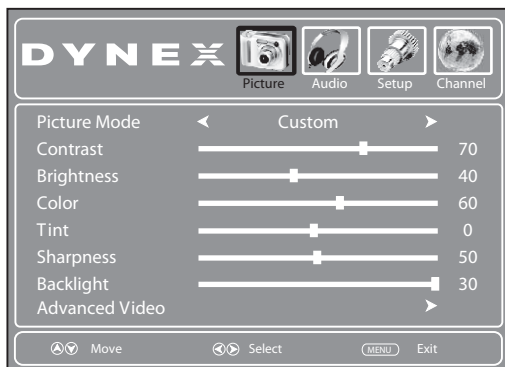

- Press **◀** or **▶** to highlight **Channel**, then press **▼**. The *Channel* menu opens. The DTV signal strength is shown at the bottom of the menu.

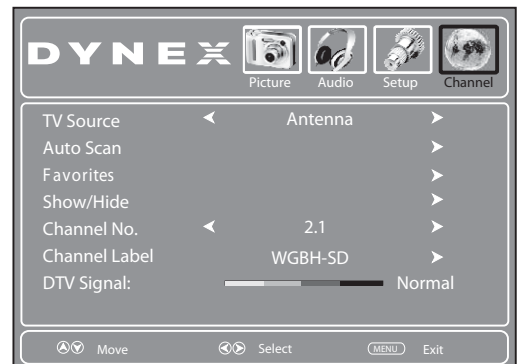

- Press **EXIT** to close the menu.

## Setting parental controls

Parental controls let you prevent your children from watching inappropriate material on TV. When set, parental controls read the rating of the program (with some exceptions, such as news and sports) and deny access to programs that exceed the ratings level you select. To watch programs that exceed the selected rating, you must enter a password.

### Turning parental controls on or off

#### To turn parental controls on or off:

- Press **MENU**. The on-screen menu opens.

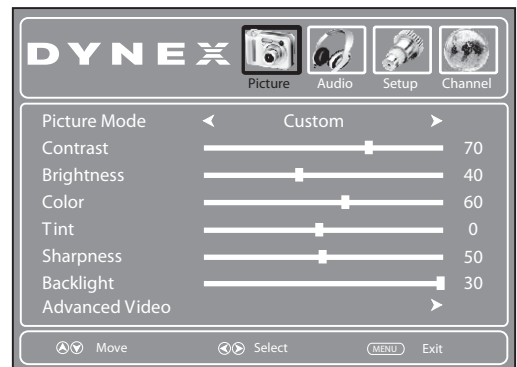

- Press **◀** or **▶** to highlight **Setup**, then press **▼**. The *Setup* menu opens.



- 3 Press **ENTER**. The *Enter Password* screen opens.



- 4 Press the number buttons to enter the four-digit password. The default password is **0000**. The *Parental Controls* sub-menu opens.

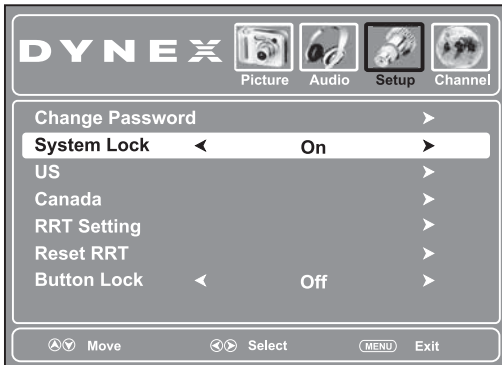

- 5 Press **▲** or **▼** to highlight **System Lock**, then press **◀** or **▶** to select **On** (to enable the blocking scheme you set up and to set up the blocking scheme (otherwise the rating setting cannot be accessed) or **Off** (to disable the blocking scheme you set up)).
- 6 Press **EXIT** to close the menu.

## Setting or changing the password

To set the parental password:

- 1 Press **MENU**. The on-screen menu opens.

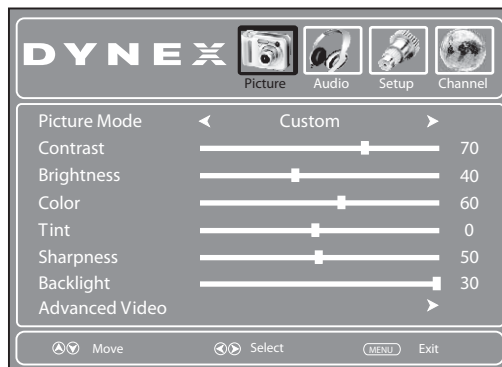

- 2 Press **◀** or **▶** to highlight **Setup**, then press **▼**. The *Setup* menu opens.



- 3 Press **ENTER**. The *Enter Password* screen opens.

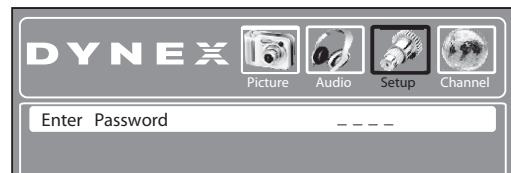

- 4 Press the number buttons to enter the four-digit password. The default password is **0000**. The *Parental Controls* sub-menu opens.

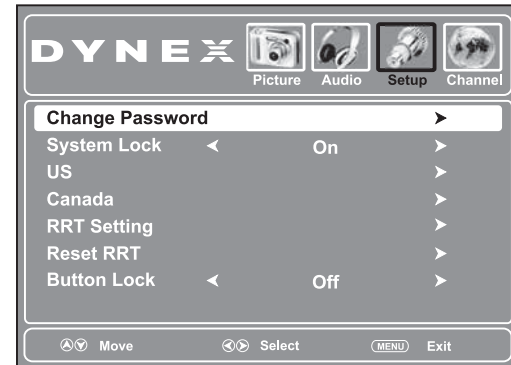

- 5 Press **▲** or **▼** to highlight **Change Password**, then press **ENTER**. The password entry screen opens.



- 6 Press the number buttons to input old password, then input a new password. On the next line, enter the new password again to confirm it. The *Parental Controls* sub-menu reopens.

**Note:** If you forget your password, enter **9999**.

- 7 Press **EXIT** to close the menu.

## Turning the button lock on or off

To turn the parental controls button lock on or off:

- 1 Press **MENU**. The on-screen menu opens.

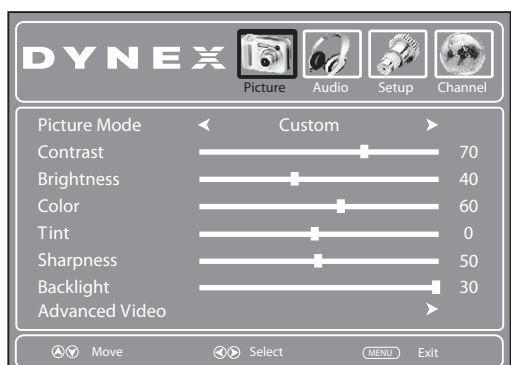



- Press **◀** or **▶** to highlight **Setup**, then press **▼**. The *Setup* menu opens.



- Press **ENTER**. The *Enter Password* screen opens.

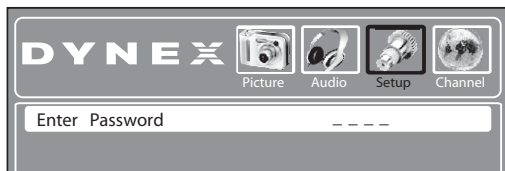

- Press the number buttons to enter your four-digit password. The *Parental Controls* sub-menu opens.
- Press **▲** or **▼** to highlight **Button Lock**, then press **◀** or **▶** to select **ON** (to turn the Button Lock on) or **OFF** (to turn the Button Lock off).

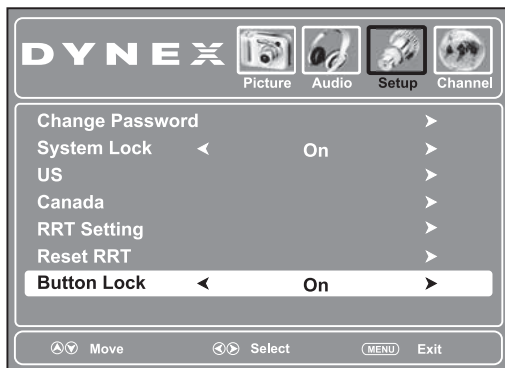

- Press **EXIT** to close the menu.

With the Button Lock on, the buttons on the TV control panel are locked. The message "Use remote to enable button" will appear every time you press a button on the TV control panel. Unplug your TV, then reconnect it to turn the Button Lock off.

## Setting parental control levels

You can set parental controls for the U.S. and Canada. The following procedure shows how to set controls for U.S. TV ratings. You use similar steps for controlling U.S. movie and Canadian TV ratings.

### To set parental controls:

- Press **MENU**. The on-screen menu opens.

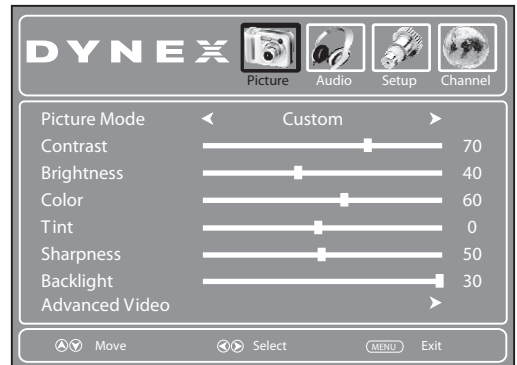

- Press **◀** or **▶** to highlight **Setup**, then press **▼**. The *Setup* menu opens.



- Press **ENTER**. The *Enter Password* screen opens.



- Press the number buttons to enter your four-digit password. The *Parental Controls* sub-menu opens.

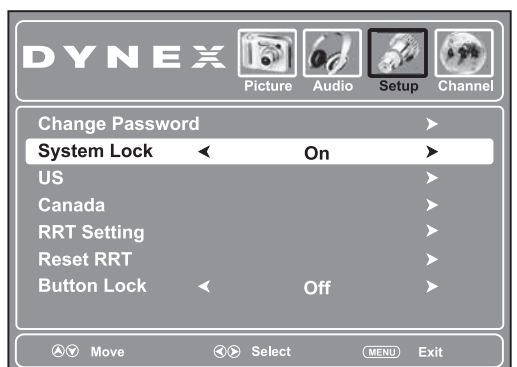

- 5 Press **▲** or **▼** to highlight **System Lock**, then press **◀** or **▶** to select **On**.

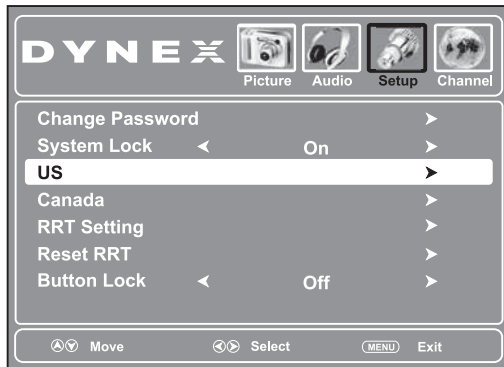

- 6 Press **▲** or **▼** to highlight **US**, then press **ENTER**. The **US Settings** sub-menu opens.

**Note:** Select **Canada** to set Canadian TV controls.



- 7 Press **▲** or **▼** to highlight **TV**, then press **ENTER**. The **US TV RATING** sub-menu opens.

**Note:** You can also select **MPAA** to set controls for US movie ratings.

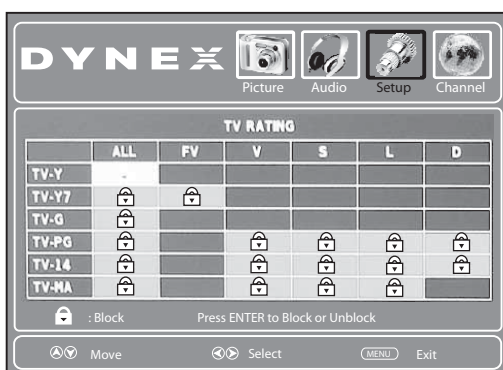

- 8 Press **▲** **▼** **◀** or **▶** to highlight the rating you want to block, then press **ENTER**. A lock symbol appears when a rating is blocked.

**Note:** On the MPAA RATING screen, press **▲** or **▼** to select the rating. That rating and all other higher ratings are blocked.

- 9 Press **EXIT** to close the menu.

#### U.S. TV ratings (age-based)

TV-Y	All children.
TV-Y7	Suitable for children 7 and older.
TV-G	General audiences.
TV-PG	Parental guidance suggested.
TV-14	Parental guidance strongly suggested.
TV-MA	Mature audiences only.

#### U. S. TV ratings (content-based)

FV	Fantasy violence.
V	Violence.
S	Sexual situations.
L	Strong language.
D	Suggestive dialog.

#### U.S. movie (MPAA) ratings

G	General audiences.
PG	Parental guidance suggested.
PG-13	Suitable for children 13 and older.
R	Parental guidance suggested for children under 17.
NC-17	Not suitable for children under 17.
X	Adults only.
N/A	Movie is not rated.

#### Canadian English ratings

C	Suitable for all children.
C8+	Suitable for children 8 and older.
G	General audiences.
PG	Parental guidance suggested.
14+	Suitable for children 14 and older.
18+	Adults only.
EXEMPT	Exempt programming.

#### Canadian French ratings

G	General audiences.
8+	Suitable for children 8 and older.
13+	Suitable for children 13 and older.
16+	Suitable for children 16 and older.
18+	Adults only.
EXEMPT	Exempt programming.

## Downloading rating information

You can download rating information to use when setting parental controls.

### To download rating information:

- 1 Press **MENU**. The on-screen menu opens.

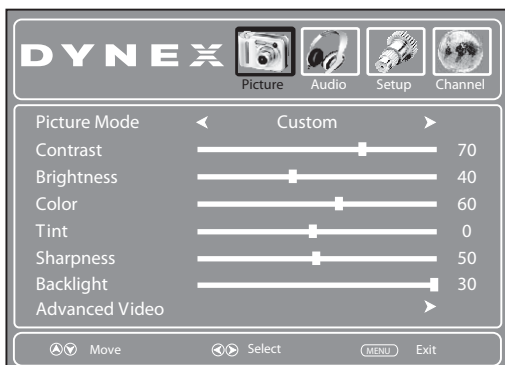

- 2 Press **◀** or **▶** to highlight **Setup**, then press **▼**. The *Setup* menu opens.

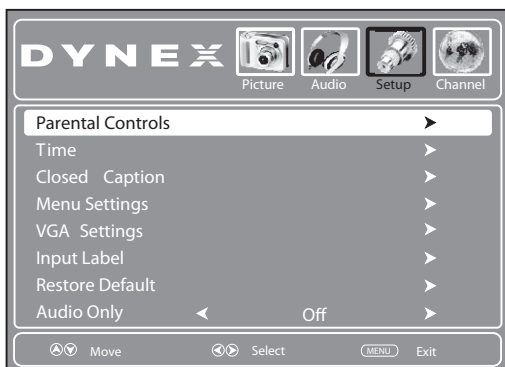

- 3 Press **ENTER**. The *Enter Password* screen opens.

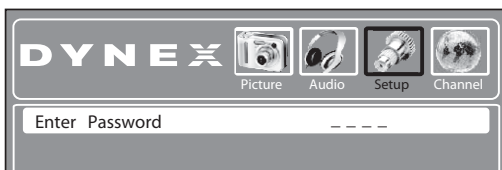

- 4 Press the number buttons to enter your four-digit password. The *Parental Controls* sub-menu opens.

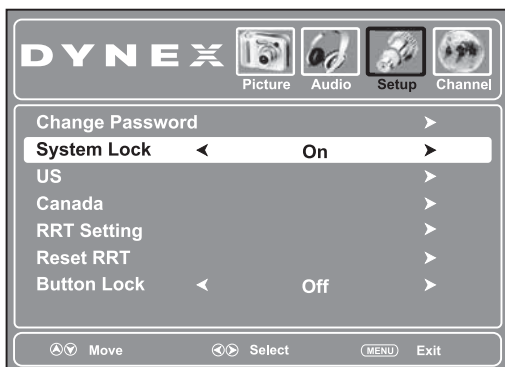

- 5 Press **▲** or **▼** to highlight **System Lock**, then press **◀** or **▶** to select **On**.

- 6 Press **▲** or **▼** to highlight **RRT Setting**, then press **ENTER**. If the program is broadcast with RRT5 rating information, the information is downloaded automatically and can be used for parental controls.

**Note:** If you want to clear the downloaded rating information, select **Reset RRT**. The rating information is cleared. If rating information is broadcast by another program, your TV downloads the new information.

## Using closed captioning

### Turning closed captioning on or off

#### To turn closed captioning on or off:

- 1 Press **MENU**. The on-screen menu opens.

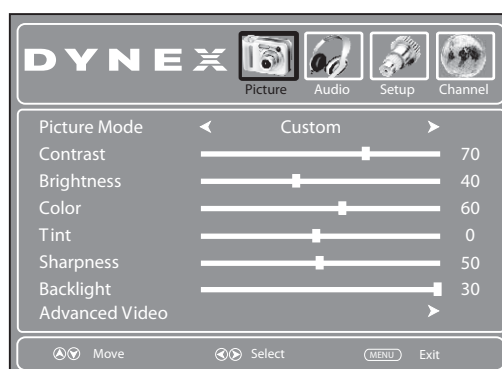

- 2 Press **◀** or **▶** to highlight **Setup**, then press **▼**. The *Setup* menu opens.



- 3 Press **▲** or **▼** to highlight **Closed Caption**, then press **▶** or **ENTER**. The closed caption menu opens.

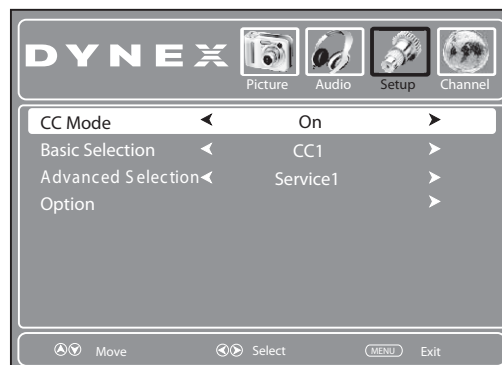

- 4 Press **▲** or **▼** to highlight **CC Mode**, then press **◀** or **▶** to select the CC mode. You can select **On** (turns on closed captioning), **CC on Mute** (turns on closed captioning when the sound is muted), or **Off** (turns off closed captioning).
- 5 Press **EXIT** to close the menu.

*Tip: You can also press **CCD** on the remote control to turn closed captioning on or off.*

## Selecting the closed captioning mode

To select the closed captioning mode:

- 1 Press **MENU**. The on-screen menu opens.

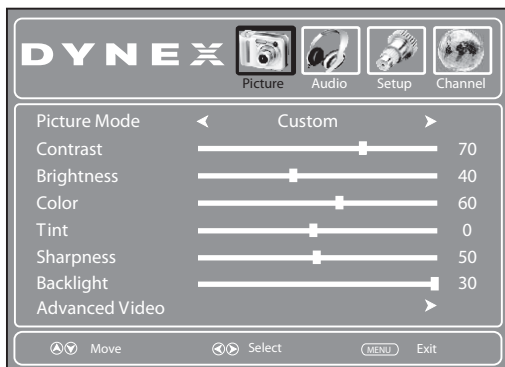

- 2 Press **◀** or **▶** to highlight **Setup**, then press **▼**. The *Setup* menu opens.

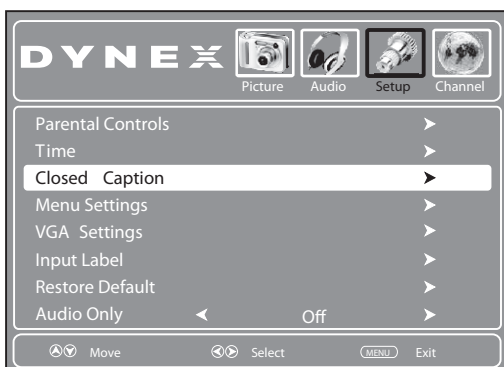

- 3 Press **▲** or **▼** to highlight **Closed Caption**, then press **▶** or **ENTER**. The closed caption menu opens.

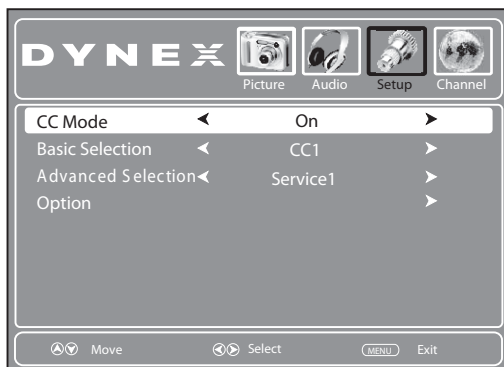

- 4 Press **▲** or **▼** to highlight **CC Mode**, then press **◀** or **▶** to select **On**.
- 5 Press **▲** or **▼** to highlight **Basic Selection**.

*Note: If the channel is analog, the Basic Selection will be available and the Advanced Selection will be grayed out (inactive).*

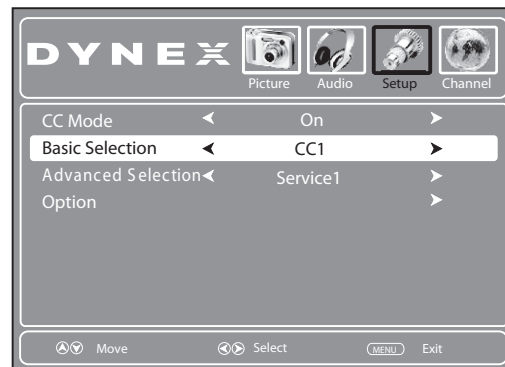

- 6 Press **◀** or **▶** to select a closed captioning mode. You can select:
  - **CC1** through **CC4**—Closed captioning appears in a small banner across the bottom of the screen. **CC1** is usually the “printed” version of the audio. **CC2** through **CC4** display content provided by the broadcaster.
  - **Text1** through **Text4**—Closed captioning that covers half or all of the screen. **Text1** through **Text4** display content provided by the broadcaster.
- 7 Press **EXIT** to close the menu.

## Customizing digital TV closed captioning styles

To customize digital TV closed captioning:

- 1 Press **MENU**. The on-screen menu opens.

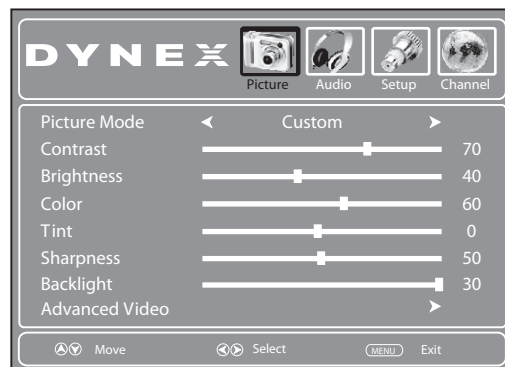

- 2 Press **◀** or **▶** to highlight **Setup**, then press **▼**. The *Setup* menu opens.

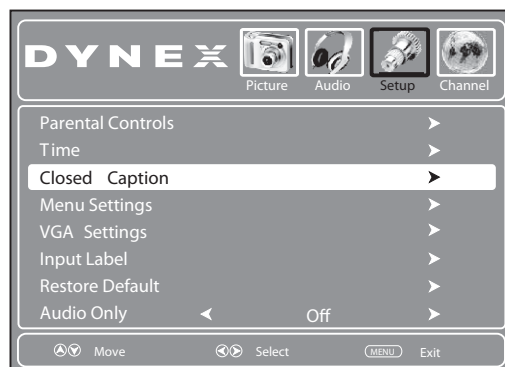

- 3 Press **▲** or **▼** to highlight **Closed Caption**, then press **▶** or **ENTER**. The closed caption menu opens.

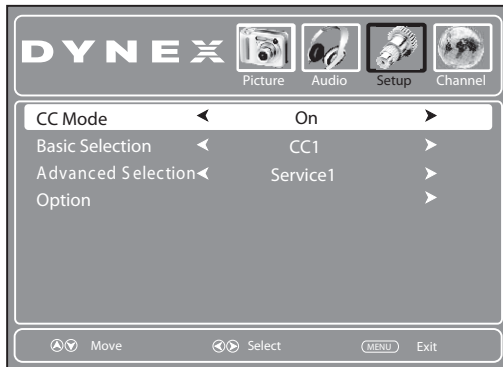

- 4 Press **▲** or **▼** to highlight **CC Mode**, then press **◀** or **▶** to select **On**.

- 5 Press **▲** or **▼** to highlight **Advanced Selection** (only available for digital stations), then press **◀** or **▶** to select an advanced digital closed captioning option. You can select **Service1 - Service6** (displays content provided by the broadcaster).

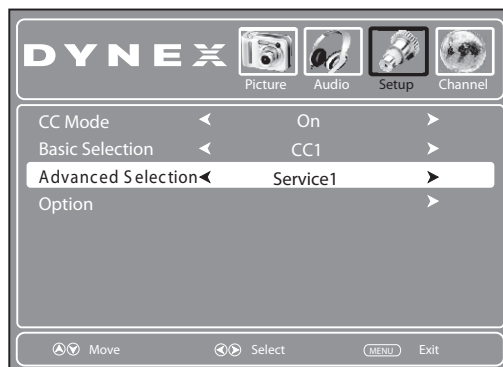

- 6 Press **▲** or **▼** to highlight **Option**, then press **ENTER**. The DTV closed captioning styles menu opens.

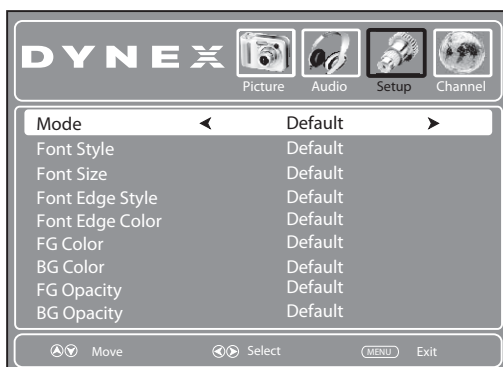

- 7 Press **▲** or **▼** to highlight **Mode**, then press **◀** or **▶** to select **Custom**.

*Note: To reset the closed captioning styles to their defaults, set **Mode** to **Default**.*

- 8 Press **▲** or **▼** to highlight a style, then press **◀** or **▶** to adjust the style. You can select:

- **Font Style**—To select a style for the words.
- **Font Size**—To select a size for the words.
- **Font Edge Style**—To select a style for the edges.
- **Font Edge Color**—To select a color for the edges.

- **FG Color**—To select a color for the text.
- **BG Color**—To select a color for the background.
- **FG Opacity**—To select the opacity for the text.
- **BG Opacity**—To select the opacity for the background.

- 9 Press **MENU** to return to the previous menu, or press **EXIT** to close the menu.

## Adjusting time settings

### Setting the date and time

To set the date and time:

- 1 Press **MENU**. The on-screen menu opens.

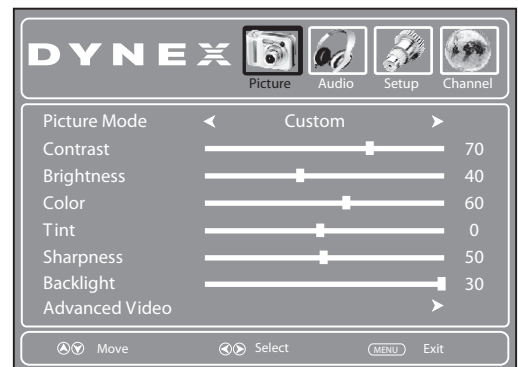

- 2 Press **◀** or **▶** to highlight **Setup**, then press **▼**. The *Setup* menu opens.



- 3 Press **▲** or **▼** to highlight **Time**, then press **ENTER**. The time setting menu opens.

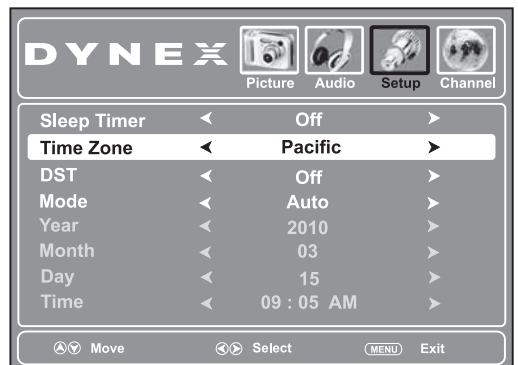

- 4 Press **▲** or **▼** to highlight **Time Zone**, then press **◀** or **▶** to select your time zone. You can select **Pacific, Alaska, Hawaii, Atlantic, Eastern, Central, or Mountain**.

- 5 If your viewing area observes daylight savings time, press ▲ or ▼ to highlight **DST**, then press ◀ or ▶ to select **On**.
- 6 Press ▲ or ▼ to highlight **Mode**, then press ◀ or ▶ to select **Manual** (to set the date/time manually), or **Auto** (the date/time are automatically set by the TV signal source, based on the time zone you selected).
- 7 If you select **Manual** mode, make the settings as follows:
  - Press ▲ or ▼ to highlight **Year, Month, or Day**, then press ◀ or ▶ to adjust the setting.
  - Set the time by pressing ▲ or ▼ to highlight **Time**, then press ◀ or ▶ to highlight the hour, minute, or AM/PM field. Press ▲ or ▼ to adjust the setting.
- 8 Press **EXIT** to close the menu.

## Setting the sleep timer

You can specify the amount of time before your TV automatically turns off.

### To set the sleep timer:

- 1 Press **MENU**. The on-screen menu opens.

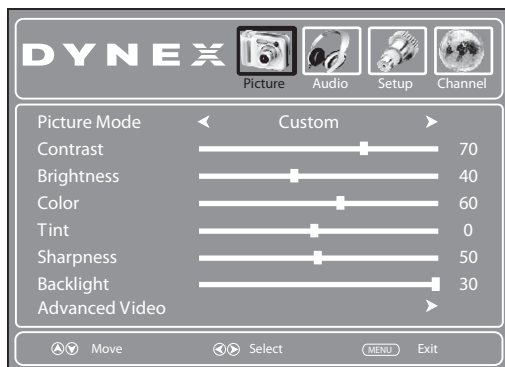

- 2 Press ◀ or ▶ to highlight **Setup**, then press ▼. The **Setup** menu opens.



- 3 Press ▲ or ▼ to highlight **Time**, then press **ENTER**. The time setting menu opens.

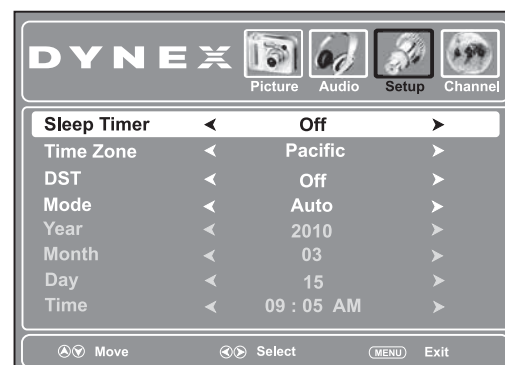

- 4 Press ▲ or ▼ to highlight **Sleep Timer**, then press ◀ or ▶ to select the amount of time you want your TV to wait before it automatically turns off.

**Note:** To turn off the sleep timer, select **Off**.

- 5 Press **EXIT** to close the menu.

**Note:** You can also press **SLEEP** on the remote control to set the sleep timer.

## Adjusting menu settings

### Selecting the menu language and transparency

To select the on-screen menu language and menu transparency:

- 1 Press **MENU**. The on-screen menu opens.

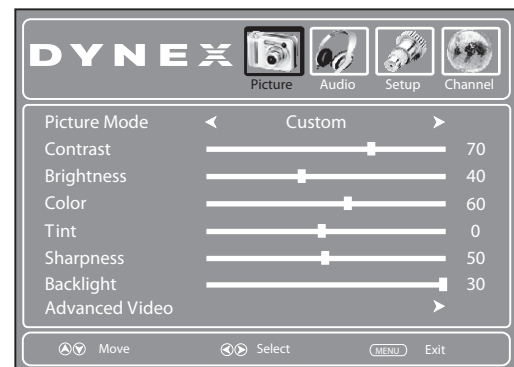

- 2 Press ◀ or ▶ to highlight **Setup**, then press ▼. The **Setup** menu opens.

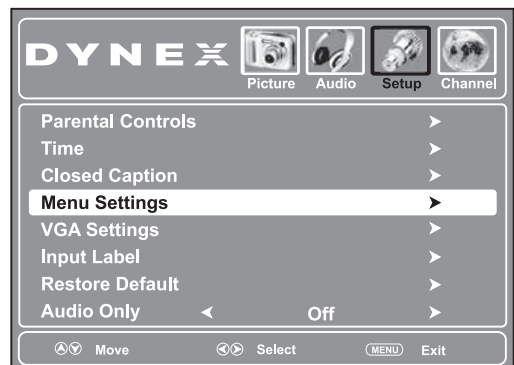

- 3 Press ▲ or ▼ to highlight **Menu Settings**, then press **ENTER**. The **Menu Settings** menu opens.



- 4 Press **▲** or **▼** to highlight **Menu Language**, then press **◀** or **▶** to select the menu language you want. Options include **English**, **French**, and **Spanish**.
- 5 Press **▲** or **▼** to select **Transparency**, then press **◀** or **▶** to select the menu transparency you want. Options include **0%**, **25%**, **50%**, **75%**, and **100%**.
- 6 Press **EXIT** to close the menu.

## Labeling an input source

You can add a label to an input source to make it easier to identify.

### To label an input source:

- 1 Press **MENU**. The on-screen menu opens.

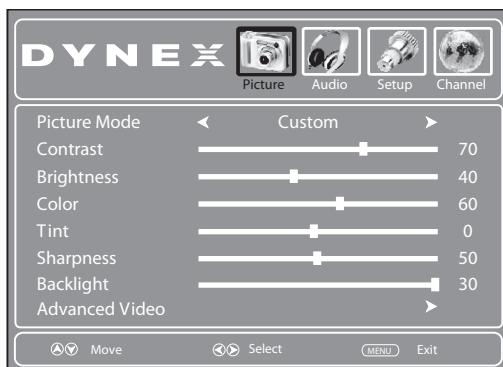

- 2 Press **◀** or **▶** to highlight **Setup**, then press **▼**. The *Setup* menu opens.



- 3 Press **▲** or **▼** to highlight **Input Label**, then press **ENTER**. The *Input Label* screen opens.

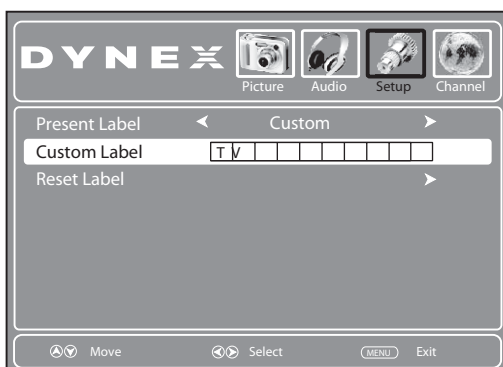

- 4 Press **◀** or **▶** to highlight a preset label from several options, or select **Custom** to enter your own label.
- 5 If you select **Custom**, press **▲** or **▼** to highlight **Custom Label**, then press **▶**.

- 6 Press **▲** or **▼** to select a character, then press **◀** or **▶** to move to the next position. Repeat this step to add more characters.
- 7 To reset the label to factory default, press **▲** or **▼** to highlight **Reset Label** then press **ENTER**. Follow the on-screen instructions.
- 8 Press **EXIT** to close the menu. The next time you press the **INPUT** button on the remote control, you will see your new label in the *INPUT SOURCE* menu.

## Restoring default settings

**Caution:** When you restore default settings, all the settings (except the password and parental rating) you have customized are reset.

### To restore default settings:

- 1 Press **MENU**. The on-screen menu opens.

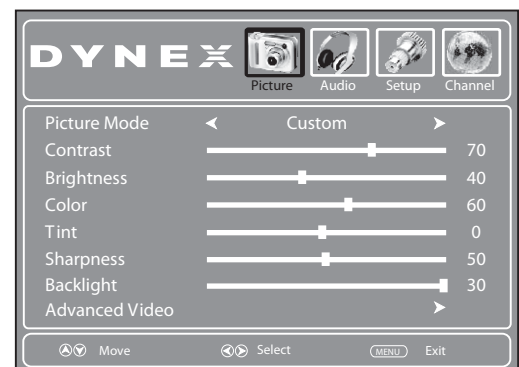

- 2 Press **◀** or **▶** to highlight **Setup**, then press **▼**. The *Setup* menu opens.

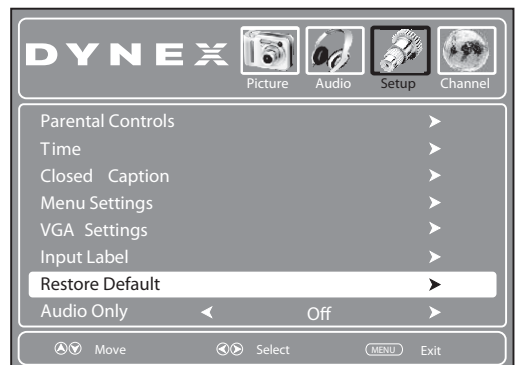

- 3 Press **▲** or **▼** to highlight **Restore Default**, then press **ENTER**. A confirmation box opens.
- 4 Press **◀** or **▶** to select **Yes**, then press **ENTER**.
- 5 Press **EXIT** to close the menu.

## Troubleshooting

Before calling for service, check the following information for possible solutions to problems you may experience. If none of these solutions work, turn off the TV, then turn it on again.

**Caution:** Do not try to repair the TV yourself. Refer all servicing to qualified repair personnel.

### Video and audio

Problem	Solution
No picture (screen is not lit) and no sound.	<ul style="list-style-type: none"> <li>Make sure that the power cord is plugged in.</li> <li>Press <b>POWER</b>  on the TV or the remote control.</li> <li>Make sure that the correct video input source is selected. For more information, see "Selecting the video input source" on page 12.</li> <li>Try another channel. The station may be experiencing problems.</li> </ul>
Dark, poor, or no picture (screen is lit), but sound is good.	<ul style="list-style-type: none"> <li>Adjust the brightness. For more information, see "Adjusting the TV picture" on page 14.</li> <li>Make sure that the correct picture mode is selected. For more information, see "Adjusting the TV picture" on page 14.</li> <li>Make sure that the antenna or cable TV is connected correctly and securely. For more information, see "Connecting an antenna, cable TV, or satellite TV box" on page 9.</li> </ul>
No color, dark picture, or color is not correct.	<ul style="list-style-type: none"> <li>Adjust the color saturation. For more information, see "Adjusting the TV picture" on page 14.</li> </ul>
Only snow (noise) appears on the screen.	<ul style="list-style-type: none"> <li>Try another channel. The station may be experiencing problems.</li> <li>Make sure that the antenna or cable TV is connected correctly and securely. For more information, see "Connecting an antenna, cable TV, or satellite TV box" on page 9.</li> <li>Check the signal strength. See "Checking digital TV signal strength" on page 19.</li> </ul>
Dotted lines or stripes appear on the screen.	<ul style="list-style-type: none"> <li>Adjust the antenna.</li> <li>Move the TV away from noise sources such as cars, neon signs, or hair dryers.</li> </ul>
Double images.	<ul style="list-style-type: none"> <li>Use a highly directional outdoor antenna or cable TV.</li> </ul>
The picture has a few bright or dark spots.	<ul style="list-style-type: none"> <li>A few bright or dark spots on an LCD screen is normal. It does not affect the operation of this TV.</li> </ul>
Good picture, but no sound.	<ul style="list-style-type: none"> <li>Make sure that the sound is not muted.</li> <li>Make sure that the sound mode is set to <b>Stereo</b> or <b>Mono</b>. For more information, see "Selecting the audio mode" on page 16.</li> </ul>
Audio noise.	<ul style="list-style-type: none"> <li>Make sure that there is no interference with infrared equipment such as a cordless telephone or headphones. Move the infrared equipment away from the TV to eliminate the noise.</li> </ul>

### Remote control

Problem	Solution
Remote control does not work.	<ul style="list-style-type: none"> <li>Make sure that the power cord is plugged in.</li> <li>Make sure that there are no obstructions between the remote control and the remote control sensor on the front of the TV.</li> <li>Make sure that the batteries are installed correctly. For more information, see "Installing remote control batteries" on page 7.</li> <li>Replace the batteries. For more information, see "Installing remote control batteries" on page 7.</li> </ul>
Trouble programming your existing universal remote control.	<ul style="list-style-type: none"> <li>See instructions and a table of common codes in "Programming a universal remote control to work with your TV" on page 8.</li> <li>Codes are subject to change. For up to date codes, go to <a href="http://www.dynexproducts.com">www.dynexproducts.com</a>.</li> <li>Replace the batteries. For more information, see "Installing remote control batteries" on page 7.</li> <li>Refer to the User Guide that accompanied your universal remote control and contact the manufacturer if problems persist.</li> </ul>

### General

Problem	Solution
One or more channels do not display.	<ul style="list-style-type: none"> <li>Make sure that the channels are not blocked. For more information, see "Setting parental control levels" on page 21.</li> <li>Make sure that the channels are not hidden. For more information, see "Hiding channels" on page 17.</li> <li>The channel may have been deleted from the channel list. You can tune to the channel by pressing the number buttons or you can add the channel back to the channel list. For more information, see "Changing channel settings" on page 17.</li> </ul>
Password is lost.	<ul style="list-style-type: none"> <li>Enter <b>9999</b> to access parental controls, then set a new password. For more information, see "Setting parental controls" on page 19.</li> </ul>
Some settings cannot be accessed.	<ul style="list-style-type: none"> <li>If a setting is grayed, the setting is not available in the current video input mode.</li> </ul>
TV cabinet creaks.	<ul style="list-style-type: none"> <li>When the TV is in use, the temperature rises naturally and may cause the cabinet to expand or contract which can cause a creaking noise. This is not a malfunction.</li> </ul>
Control buttons on the TV do not work.	<ul style="list-style-type: none"> <li>Disconnect the power cord, wait a few seconds, then reconnect the power cord and turn on the TV.</li> </ul>



*Note: If the problem is not solved by using these troubleshooting instructions, try turning off your TV, then turning it on again.*

## Maintenance

### Cleaning

- Clean your TV with a soft, dry cloth. If surfaces are extremely dirty, use a soft cloth dampened with a weak detergent solution.
- Use an eyeglass cleaner to clean the screen. Never use alcohol, paint thinner, or benzene.
- Before using a chemically treated cloth, read the instructions that came with the cloth.

## Specifications

Specifications subject to change without notice.  
Weight and dimensions shown are approximate.

<b>TV type</b>	LCD
<b>TV panel</b>	32-inch TFT LCD (DX-32L151A11) 37-inch TFT LCD (DX-37L130A11)
<b>TV system</b>	NTSC-M, ATSC
<b>Receiving channels</b>	VHF: 2 - 13 UHF: 14 - 69 CATV: 1 - 125 CADTV: 1-135 DTV: 2-69
<b>Audio multiples</b>	BTSC system
<b>Audio out</b>	8 W x 2 (32") 10 W x 2 (37")
<b>Power requirement</b>	AC 120 V, 60 Hz
<b>Power consumption</b>	98 W (32") 145 W (37")
<b>Dimensions (W x H x D with stand)</b>	30.55 x 21.5 x 10.4 inches (776 x 546 x 255 mm) - 32" 35.4 x 24.8 x 11 inches (899 x 631 x 280 mm) - 37"
<b>Weight</b>	25.35 lbs. (11.5 kg) - 32" 36.15 lbs. (16.4 kg) - 37"
<b>Input terminals</b>	Composite video/L and R audio (1) Component video/L and R audio (1) HDMI (2) VGA/audio (1) Antenna (1)
<b>Output terminals</b>	Audio left and right (1) Digital optical (1) Headphone (1)
<b>Control terminals</b>	SERVICE PORT (1)

This equipment has been tested and found to comply within the limits for a class B digital device, pursuant to Part 15 of the FCC Rules. These limits are designed to provide reasonable protection against harmful interference in a residential installation. This equipment generates, uses, and can radiate radio frequency energy and, if not installed and used in accordance with the instructions, may cause harmful interference to radio communications. However, there is no guarantee that interference will not occur in a particular installation. If this equipment does cause harmful interference to radio or television reception, which can be determined by turning the equipment off and on, the user is encouraged to try to correct the interference by one or more of the following measures:

- Reorient or relocate the receiving antenna.
- Increase the separation between the equipment and receiver.
- Connect the equipment into an outlet on a circuit different from that to which the receiver is connected.
- Consult the dealer or an experienced technician for help.

### FCC warning

Changes or modifications not expressly approved by the party responsible for compliance with the FCC Rules could void the user's authority to operate this equipment.

### Cables

Connections to this device must be made with shielded cables with metallic RF/EMI connector hoods to maintain compliance with FCC Rules and Regulations.

### Canada ICES-003 statement

This Class B digital apparatus complies with Canadian ICES-003.  
Cet appareil numérique de la classe B est conforme à la norme NMB-003 du Canada.

Standard Television Receiving Apparatus — Appareil de réception télévision ordinaire, Canada BETS-7 / NTMR-7

### HDMI

# HDMI®

HIGH-DEFINITION MULTIMEDIA INTERFACE

HDMI, the HDMI logo, and High-Definition Multimedia Interface are trademarks or registered trademarks of HDMI Licensing LCC.

## Legal notices

### FCC Part 15

This device complies with Part 15 of the FCC Rules. Operation of this product is subject to the following two conditions: (1) this device may not cause harmful interference, and (2) this device must accept any interference received, including interference that may cause undesired operation.



# One-year limited warranty

## US and Canada Markets

### Definitions:

Dynex Products ("Dynex") warrants to you, the original purchaser of this new Dynex-branded television ("Product"), that the Product shall be free of defects in the original manufacturer of the material or workmanship for a period of one (1) year from the date of your purchase of the Product ("Warranty Period"). For this warranty to apply, your Product must be purchased in the United States or Canada from a Best Buy or Future Shop authorized dealer of Dynex brand products only that are packaged with this warranty statement.

### How long does the coverage last?

The Warranty Period lasts for 1 year (365 days) from the date you purchased the Product. Your purchase date is printed on the receipt you received with the Product.

### What does this warranty cover?

During the Warranty Period, if the original manufacture of the material or workmanship of the Product is determined to be defective by an authorized Dynex repair center or store personnel, Dynex will (at its sole option): (1) repair the Product with new or rebuilt parts; or (2) replace the Product at no charge with new or rebuilt comparable products or parts. Products and parts replaced under this warranty become the property of Dynex and are not returned to you. If service of Products or parts are required after the Warranty Period expires, you must pay all labor and parts charges. This warranty lasts as long as you own your Dynex Product during the Warranty Period. Warranty coverage terminates if you sell or otherwise transfer the Product.

### How to obtain warranty service?

If you purchased the Product at a Best Buy or Future Shop retail store location and your television Product has a screen size of less than 37 inches, please take your original receipt and the Product to any Best Buy or Future Shop store. Make sure that you place the Product in its original packaging or packaging that provides the same amount of protection as the original packaging. If you purchased the Product from a Best Buy or Future Shop online web site, mail your original receipt and the Product to the address listed on the web site. Make sure that you put the Product in its original packaging or packaging that provides the same amount of protection as the original packaging. To obtain in-home warranty service for a television with a screen 37 inches or larger, in the United States call 1-888-BESTBUY, Canada call 1-866-BESTBUY for Future Shop call 1-800-663-2275. Call agents will diagnose and correct the issue over the phone or will have a Dynex-approved repair technician dispatched to your home.

### Where is the warranty valid?

This warranty is valid only to the original purchaser of the product in the United States and Canada at Best Buy or Future Shop branded retail stores or websites.

### What does the warranty not cover?

This warranty does not cover:

- Customer instruction/education
- Installation
- Set up adjustments
- Cosmetic damage
- Damage due to acts of God, such as power surges
- Accident(s)
- Misuse
- Abuse
- Negligence
- Commercial purposes/use, including but not limited to use in a place of business or in communal areas of a multiple dwelling condominium or apartment complex, or otherwise used in a place of other than a private home.
- Modification of any part of the Product, including the antenna
- Plasma display panel damaged by static (non-moving) images applied for lengthy periods (burn-in).
- Damage due to incorrect operation or maintenance
- Connection to an incorrect voltage or power supply
- Attempted repair by any person not authorized by Dynex to service the Product
- Products sold "as is" or "with all faults"
- Consumables, including but not limited to batteries (i.e. AA, AAA, C etc.)
- Products where the factory applied serial number has been altered or removed
- Loss or Theft of this product or any part of the product

REPAIR REPLACEMENT AS PROVIDED UNDER THIS WARRANTY IS YOUR EXCLUSIVE REMEDY FOR BREACH OF WARRANTY. DYNEX SHALL NOT BE LIABLE FOR ANY INCIDENTAL OR CONSEQUENTIAL DAMAGES FOR THE BREACH OF ANY EXPRESS OR IMPLIED WARRANTY ON THIS PRODUCT, INCLUDING, BUT NOT LIMITED TO, LOST DATA, LOSS OF USE OF YOUR PRODUCT, LOST BUSINESS OR LOST PROFITS. DYNEX PRODUCTS MAKES NO OTHER EXPRESS WARRANTIES WITH RESPECT TO THE PRODUCT, ALL EXPRESS AND IMPLIED WARRANTIES FOR THE PRODUCT, INCLUDING, BUT NOT LIMITED TO, ANY IMPLIED WARRANTIES OF AND CONDITIONS OF MERCHANTABILITY AND FITNESS FOR A PARTICULAR PURPOSE, ARE LIMITED IN DURATION TO THE WARRANTY PERIOD SET FORTH ABOVE AND NO WARRANTIES, WHETHER EXPRESS OR IMPLIED, WILL APPLY AFTER THE WARRANTY PERIOD. SOME STATES, PROVINCES AND JURISDICTIONS DO NOT ALLOW LIMITATIONS ON HOW LONG AN IMPLIED WARRANTY LASTS, SO THE ABOVE LIMITATION MAY NOT APPLY TO YOU. THIS WARRANTY GIVES YOU SPECIFIC LEGAL RIGHTS, AND YOU MAY ALSO HAVE OTHER RIGHTS, WHICH VARY FROM STATE TO STATE OR PROVINCE TO PROVINCE.

Contact Dynex:

For customer service please call 1-800-305-2204

www.Dynexproducts.com

Distributed by Best Buy Purchasing, LLC

7601 Penn Avenue South, Richfield, Minnesota, U.S.A. 55423-3645

© 2010 BBY Solutions, Inc.

All rights reserved. DYNEX is a trademark of BBY Solutions, Inc. Registered in some countries. All other products and brand names are trademarks of their respective owners.

## Mexico Market

{RETAILER SEAL}

PLACE STICKER OF PRODUCT MAKE & MODEL HERE

DATE OF PURCHASE: \_\_\_\_\_

### Definitions:

Dynex Products ("Dynex") warrants to you, the original purchaser of this new Dynex-branded television ("Product"), that the Product shall be free of defects in the original manufacturer of the material or workmanship for a period of one (1) year from the date of your purchase of the Product ("Warranty Period"). For this warranty to apply, your Product must be purchased in the United States or Canada from a Best Buy or Future Shop authorized dealer of Dynex brand products only that are packaged with this warranty statement.

### How long does the coverage last?

The Warranty Period lasts for 1 year (365 days) from the date you purchased the Product. Your purchase date is printed on the receipt you received with the Product.

### What does this warranty cover?

During the Warranty Period, if the original manufacture of the material or workmanship of the Product is determined to be defective by an authorized Dynex repair center or store personnel, Dynex will (at its sole option): (1) repair the Product with new or rebuilt parts; or (2) replace the Product at no charge with new or rebuilt comparable products or parts. Products and parts replaced under this warranty become the property of Dynex and are not returned to you. If service of Products or parts are required after the Warranty Period expires, you must pay all labor and parts charges. This warranty lasts as long as you own your Dynex Product during the Warranty Period. Warranty coverage terminates if you sell or otherwise transfer the Product.

### How to obtain warranty service?

If you purchased the Product at a Best Buy retail store location and your television Product has a screen size of less than 37 inches, please take your original receipt and the Product to any Best Buy store. Make sure that you place the Product in its original packaging or packaging that provides the same amount of protection as the original packaging. If you purchased the Product from a Best Buy online web site, mail your original receipt and the Product to the address listed on the web site. Make sure that you put the Product in its original packaging or packaging that provides the same amount of protection as the original packaging.

To obtain in-home warranty service for a television with a screen 37 inches or larger, in Mexico call 01 800-433-5778. Call agents will diagnose and correct the issue over the phone or will have a Dynex-approved repair technician dispatched to your home.

### Where is the warranty valid?

This warranty is valid only to the original purchaser of the product in Mexico at a Best Buy branded retail stores or website.

### What does the warranty not cover?

This warranty does not cover:

- Customer instruction/education
- Installation
- Set up adjustments
- Cosmetic damage
- Damage due to acts of God, such as power surges
- Accident(s)
- Misuse
- Abuse
- Negligence
- Commercial purposes/use, including but not limited to use in a place of business or in communal areas of a multiple dwelling condominium or apartment complex, or otherwise used in a place of other than a private home.
- Modification of any part of the Product, including the antenna
- Plasma display panel damaged by static (non-moving) images applied for lengthy periods (burn-in).
- Damage due to incorrect operation or maintenance
- Connection to an incorrect voltage or power supply
- Attempted repair by any person not authorized by Dynex to service the Product
- Products sold "as is" or "with all faults"
- Consumables, including but not limited to batteries (i.e. AA, AAA, C etc.)
- Products where the factory applied serial number has been altered or removed
- Loss or Theft of this product or any part of the product

REPAIR REPLACEMENT AS PROVIDED UNDER THIS WARRANTY IS YOUR EXCLUSIVE REMEDY FOR BREACH OF WARRANTY. DYNEX SHALL NOT BE LIABLE FOR ANY INCIDENTAL OR CONSEQUENTIAL DAMAGES FOR THE BREACH OF ANY EXPRESS OR IMPLIED WARRANTY ON THIS PRODUCT, INCLUDING, BUT NOT LIMITED TO, LOST DATA, LOSS OF USE OF YOUR PRODUCT, LOST BUSINESS OR LOST PROFITS. DYNEX PRODUCTS MAKES NO OTHER EXPRESS WARRANTIES WITH RESPECT TO THE PRODUCT, ALL EXPRESS AND IMPLIED WARRANTIES FOR THE PRODUCT, INCLUDING, BUT NOT LIMITED TO, ANY IMPLIED WARRANTIES OF AND CONDITIONS OF MERCHANTABILITY AND FITNESS FOR A PARTICULAR PURPOSE, ARE LIMITED IN DURATION TO THE WARRANTY PERIOD SET FORTH ABOVE AND NO WARRANTIES, WHETHER EXPRESS OR IMPLIED, WILL APPLY AFTER THE WARRANTY PERIOD. SOME STATES, PROVINCES AND JURISDICTIONS DO NOT ALLOW LIMITATIONS ON HOW LONG AN IMPLIED WARRANTY LASTS, SO THE ABOVE LIMITATION MAY NOT APPLY TO YOU. THIS WARRANTY GIVES YOU SPECIFIC LEGAL RIGHTS, AND YOU MAY ALSO HAVE OTHER RIGHTS, WHICH VARY FROM STATE TO STATE OR PROVINCE TO PROVINCE.

Contact Dynex:

For service, please call 01 800-926-3020

[www.dynexproducts.com](http://www.dynexproducts.com)

Distributed by Best Buy Imports, S. de R.L. de C.V.

Av. Santa Fe 485, Segundo Piso,

Colonia Cruz Manca,

Programa Parcial de Desarrollo Santa Fe,

Delegación Cuajimalpa, Distrito

Federal, México 05349

RFC#BBI0802114Q2

© 2010 BBY Solutions, Inc.

All rights reserved. DYNEX is a trademark of BBY Solutions, Inc. Registered in some countries. All other products and brand names are trademarks of their respective owners.

**DYNEX**™

If the power cord has been damaged, it should be replaced by the manufacturer, your service provider or qualified personnel to avoid risks.

Si el cordón de alimentación es dañado, este debe ser remplazado por el fabricante o su agente de servicio o por personal calificado para evitar el riesgo.

[www.dynexproducts.com](http://www.dynexproducts.com)

US and Canada Market - (800) 305-2204

Mexico Market - 01 800-926-3020

Distributed by Best Buy Purchasing, LLC  
7601 Penn Ave. South, Richfield, MN 55423 U.S.A.

© 2010 BBY Solutions, Inc. All rights reserved.

DYNEX is a trademark of BBY Solutions, Inc. Registered in some countries. All other products and brand names are trademarks of their respective owners.

Best Buy Imports, S. de R.L. de C.V. Av. Santa Fe 485, Segundo Piso, Colonia Cruz Manca, Programa Parcial de Desarrollo Santa Fe, Delegación Cuajimalpa, Distrito Federal, México 05349

10-0567  
ENGLISH

RFC#BBI0802114Q2

Se incluye el manual. Favor de leer este manual antes de usar el producto.

Para el Soporte técnico de Dynex en México,  
favor llame al:01 800-926-3020 <http://www.dynexproducts.com>